

ANGELA-XW-B

White version with ~70° wide beam compatible with BJB connectors

TECHNICAL SPECIFICATIONS:

| | |
|-----------------|--------------------|
| Dimensions | Ø 119.5 mm |
| Height | 74.5 mm |
| Fastening | socket |
| Colour | white |
| Box size | 480 x 280 x 300 mm |
| Box weight | 7.7 kg |
| Quantity in Box | 160 pcs |
| ROHS compliant | yes ⓘ |



MATERIAL SPECIFICATIONS:

| Component | Type | Material | Colour | Coating |
|-------------|-----------|----------|--------|---------|
| ANGELA-XW-B | Reflector | HRPC | white | |

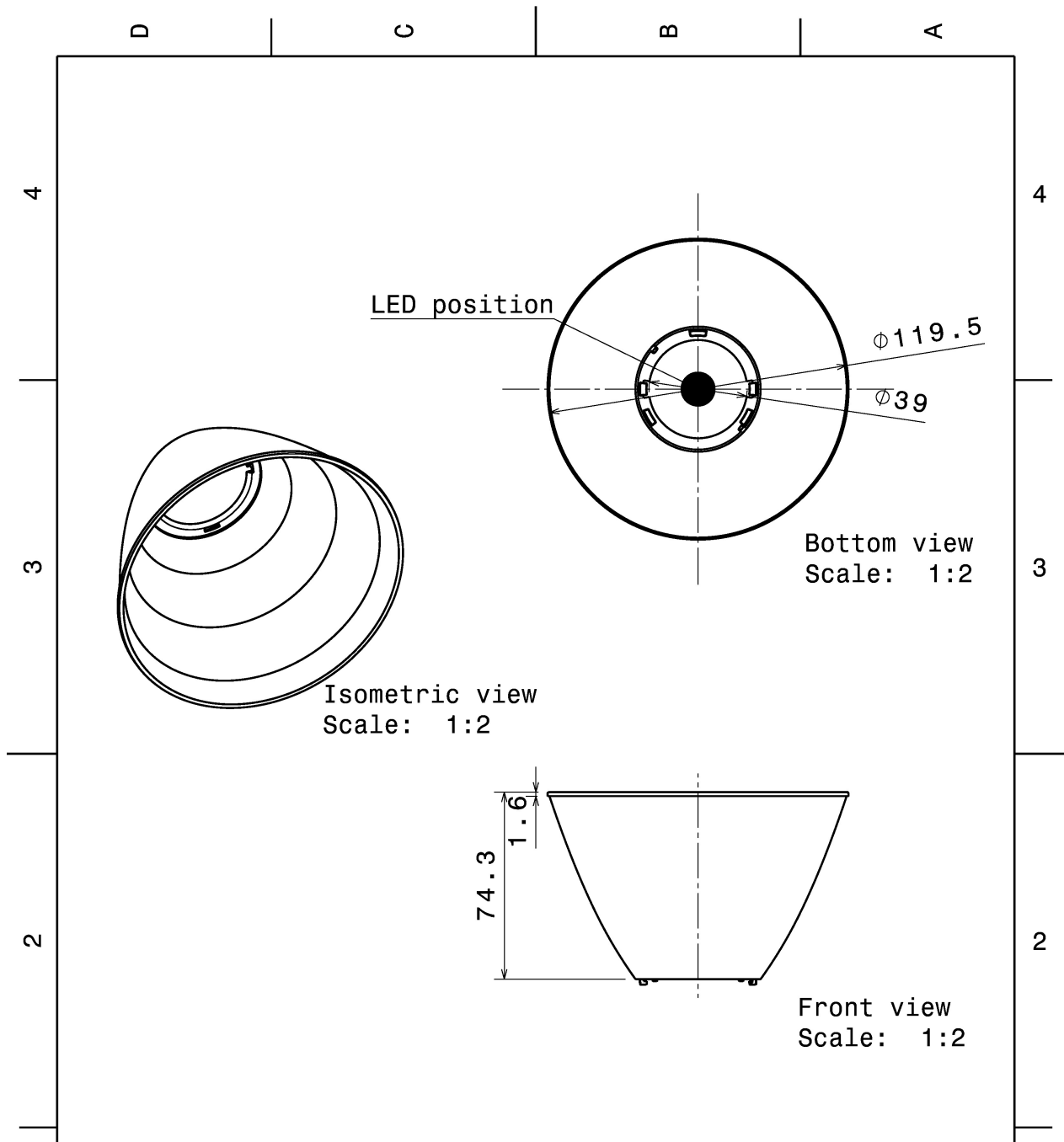

Tolerances if not otherwise shown
According to DIN ISO 2768-1
Linear measures:
Up to 30mm class M, otherwise class C.
According to DIN ISO 2768-2
Form and position: class L

LEDiL

Ledil Oy
Salorankatu 10
FIN 24240 SALO
Finland

THIRD ANGLE PROJECTION:

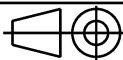

DRAWING TITLE

Angela-B

This drawing is the property
of LEDiL Oy. It may not be
reproduced, copied or
communicated without a written
agreement with LEDiL Oy."

SIZE PART NUMBER

A4

-

SCALE 1:2 WEIGHT

-

SHEET 1/1

PHOTOMETRIC DATA (MEASURED):

| | | |
|---|--|---|
| <p>bridgelux.</p> <p>LED BXRA ES Rectangle</p> <p>FWHM 73.0°</p> <p>Efficiency 94 %</p> <p>Peak intensity 0.640 cd/lm</p> <p>Required components:</p> <p>BJB: 47.319.2040</p> |  |  |
| <p>bridgelux.</p> <p>LED V18 Gen7</p> <p>FWHM 72.0°</p> <p>Efficiency 94 %</p> <p>Peak intensity 0.640 cd/lm</p> <p>Required components:</p> <p>BJB: 47.319.2350</p> |  |  |
| <h3>CITIZEN</h3> <p>LED CLL03x/CLU03x</p> <p>FWHM 72.0°</p> <p>Efficiency 94 %</p> <p>Peak intensity 0.660 cd/lm</p> <p>Required components:</p> <p>BJB: 47.319.2021</p> |  |  |
| <h3>CITIZEN</h3> <p>LED CLL03x/CLU03x</p> <p>FWHM 72.0°</p> <p>Efficiency 94 %</p> <p>Peak intensity 0.640 cd/lm</p> <p>Required components:</p> <p>A.A.G. STUCCHI: 8101/G2</p> |  |  |

PHOTOMETRIC DATA (MEASURED):

CITIZEN

LED CLL03x/CLU03x
FWHM 73.0°
Efficiency 88 %
Peak intensity 0.590 cd/lm
Required components:
F13671_ANGLE-RZ-LENS
A.A.G. STUCCHI: 8101/G2

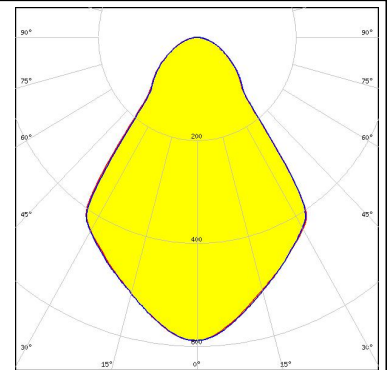

CITIZEN

LED CLL04x/CLU04x
FWHM 72.0°
Efficiency 85 %
Peak intensity 0.580 cd/lm
Required components:
F13671_ANGLE-RZ-LENS
A.A.G. STUCCHI: 8102/G2

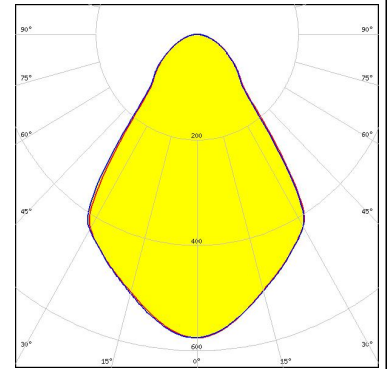

CITIZEN

LED CLL04x/CLU04x
FWHM 71.0°
Efficiency 93 %
Peak intensity 0.600 cd/lm
Required components:
BJB: 47.319.2030

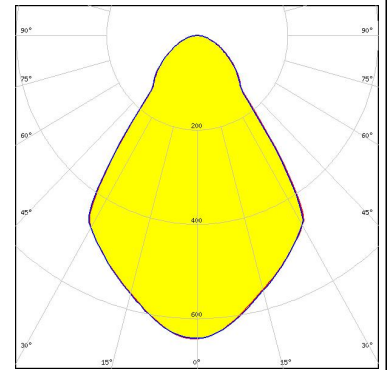
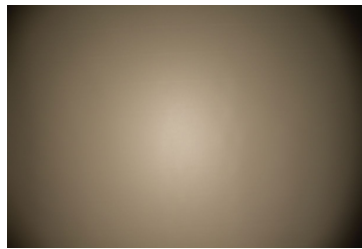

CITIZEN

LED CLL04x/CLU04x
FWHM 72.0°
Efficiency 93 %
Peak intensity 0.620 cd/lm
Required components:
A.A.G. STUCCHI: 8102/G2

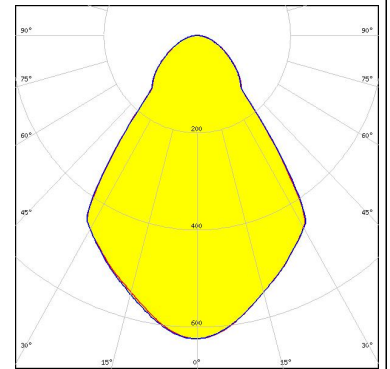
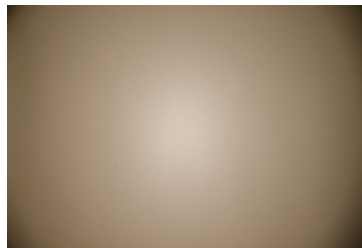

PHOTOMETRIC DATA (MEASURED):

CITIZEN

LED CLU720/721
FWHM 73.0°
Efficiency 94 %
Peak intensity 0.650 cd/lm
Required components:
BJB: 47.319.2021

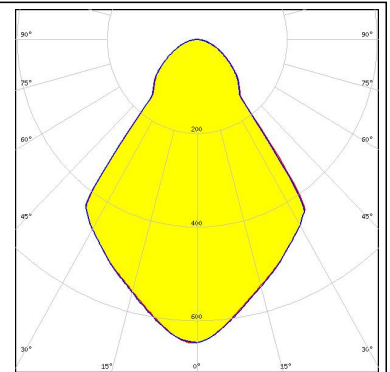

CITIZEN

LED CLU720/721
FWHM 72.0°
Efficiency 94 %
Peak intensity 0.640 cd/lm
Required components:
A.A.G. STUCCHI: 8101/G2

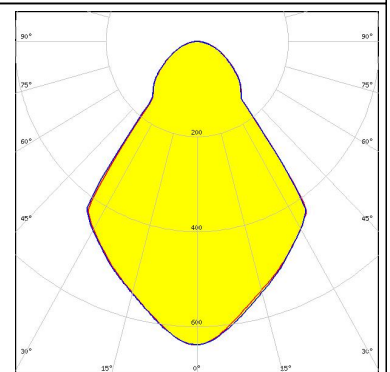
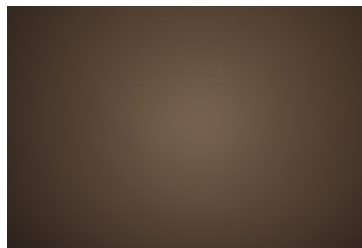

CREE 

LED CXA/B 25xx
FWHM 72.0°
Efficiency 93 %
Peak intensity 0.640 cd/lm
Required components:
BJB: 47.319.2141

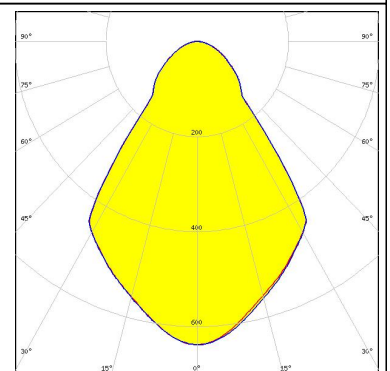
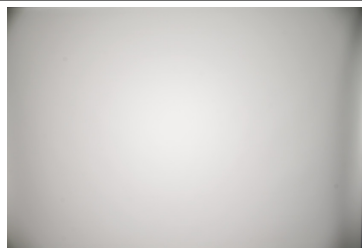

CREE 

LED CXA/B 25xx
FWHM 73.0°
Efficiency 93 %
Peak intensity 0.630 cd/lm
Required components:
A.A.G. STUCCHI: 8401/G2

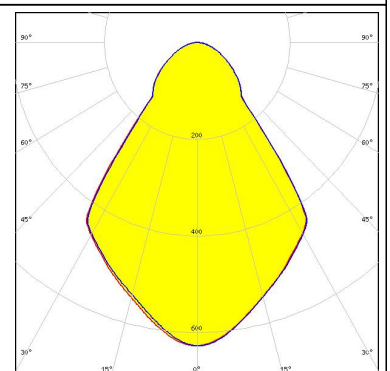
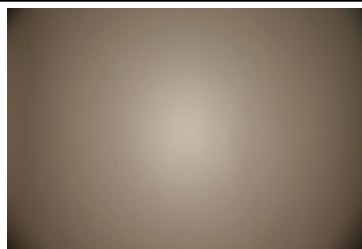

PHOTOMETRIC DATA (MEASURED):



LED CXA/B 25xx
 FWHM 72.0°
 Efficiency 89 %
 Peak intensity 0.600 cd/lm
 Required components:
 F13671_ANGE-RZ-LENS
 BJB: 47.319.2141

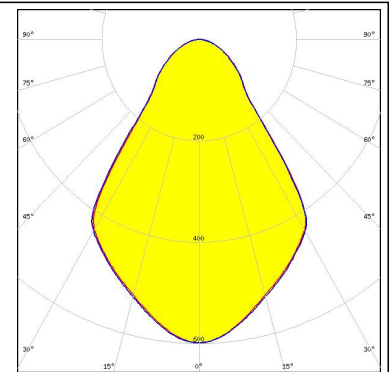

LED CXA/B 30xx
 FWHM 71.0°
 Efficiency 92 %
 Peak intensity 0.640 cd/lm
 Required components:
 A.A.G. STUCCHI: 8404/G2

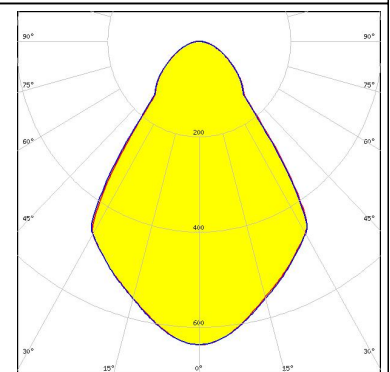
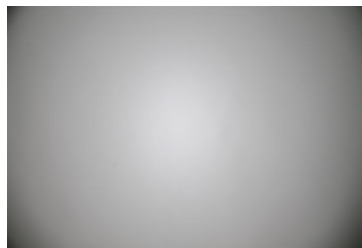

LED COB 10W/13W/17W/24W
 FWHM 73.0°
 Efficiency 94 %
 Peak intensity 0.640 cd/lm
 Required components:
 A.A.G. STUCCHI: 8600/G2

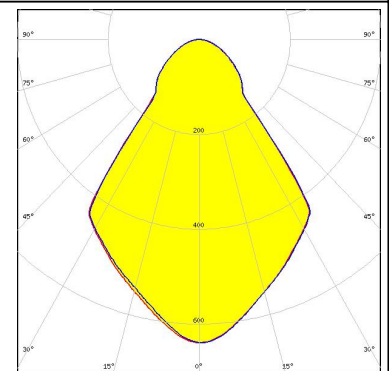
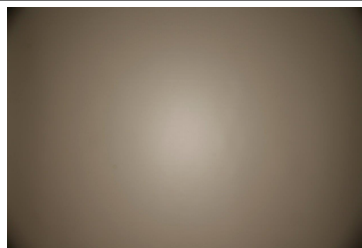

LED COB 10W/13W/17W/24W
 FWHM 73.0°
 Efficiency 94 %
 Peak intensity 0.700 cd/lm
 Required components:
 BJB: 47.319.2080

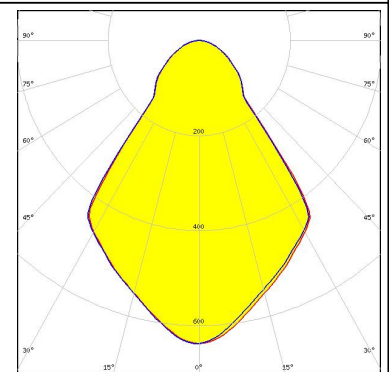
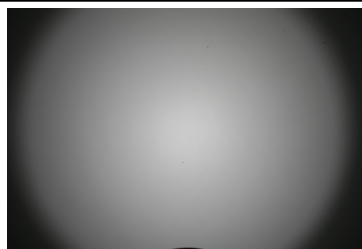

PHOTOMETRIC DATA (MEASURED):

LG Innotek

LED COB 40W/60W
 FWHM 72.0°
 Efficiency 92 %
 Peak intensity 0.620 cd/lm
 Required components:
 A.A.G. STUCCHI: 8102/G2

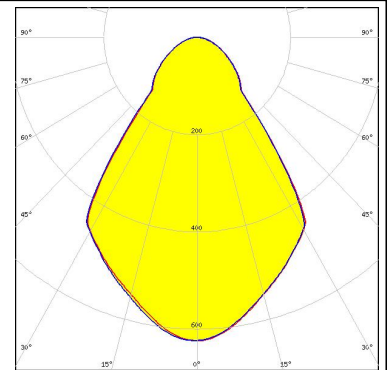
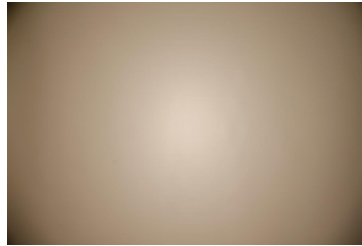

LUMILEDS

LED LUXEON CoB 1204/1205
 FWHM 73.0°
 Efficiency 94 %
 Peak intensity 0.640 cd/lm
 Required components:
 A.A.G. STUCCHI: 8301/G2

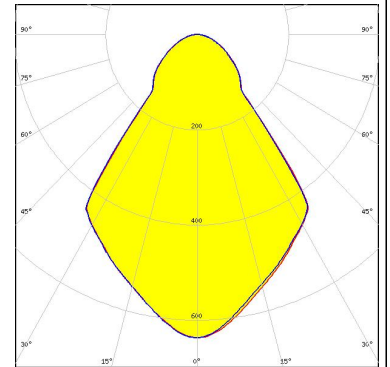
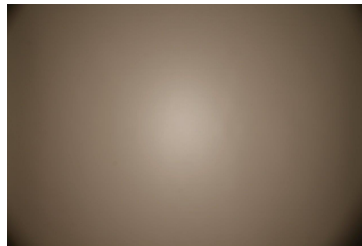

LUMILEDS

LED LUXEON CoB 1208
 FWHM 73.0°
 Efficiency 94 %
 Peak intensity 0.630 cd/lm
 Required components:
 A.A.G. STUCCHI: 8301/G2

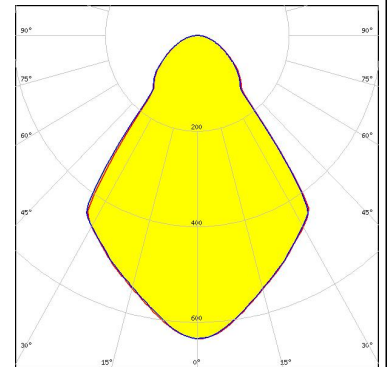
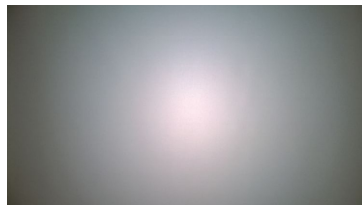

LUMILEDS

LED LUXEON CoB 1211
 FWHM 71.0°
 Efficiency 93 %
 Peak intensity 0.640 cd/lm
 Required components:
 A.A.G. STUCCHI: 8102/G2

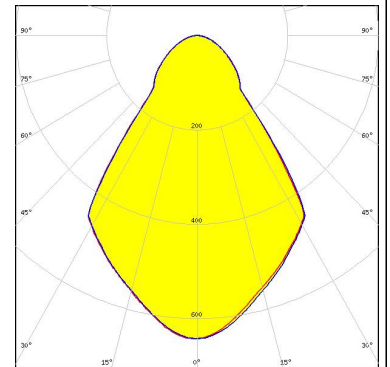
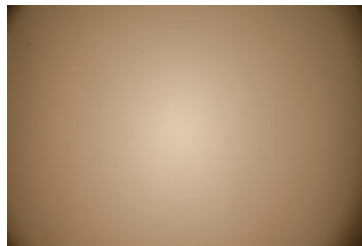

PHOTOMETRIC DATA (MEASURED):

LUMILEDS

LED LUXEON CoB 1211
FWHM 72.0°
Efficiency 93 %
Peak intensity 0.630 cd/lm
Required components:
BJB: 47.319.2030

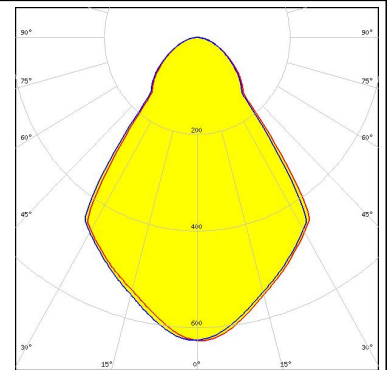

LUMILEDS

LED LUXEON CoB 1216/1812
FWHM 71.0°
Efficiency 88 %
Peak intensity 0.590 cd/lm
Required components:
F13671_ANGE-RZ-LENS
BJB: 47.319.2030

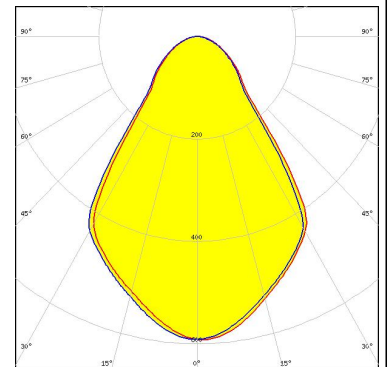

LUMILEDS

LED LUXEON CoB 1216/1812
FWHM 72.0°
Efficiency 93 %
Peak intensity 0.630 cd/lm
Required components:
BJB: 47.319.2030

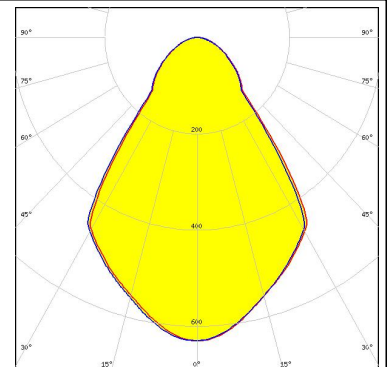
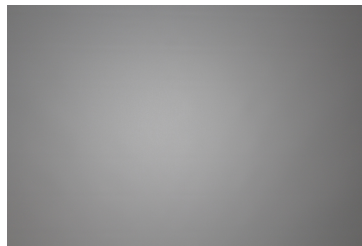

LUMILEDS

LED LUXEON K12
FWHM 72.0°
Efficiency 94 %
Peak intensity 0.700 cd/lm
Required components:
BJB: 47.319.2070

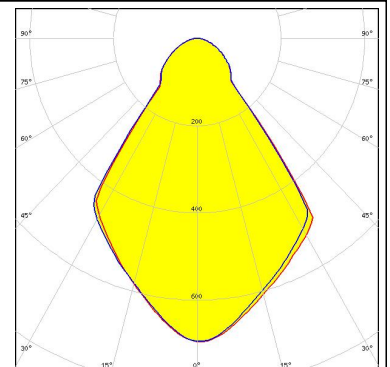

PHOTOMETRIC DATA (MEASURED):



LED LUXEON K16
 FWHM 72.0°
 Efficiency 94 %
 Peak intensity 0.700 cd/lm
 Required components:
 BJB: 47.319.2070

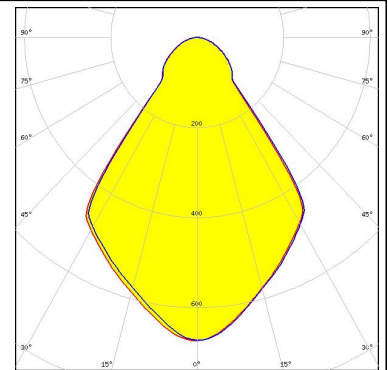
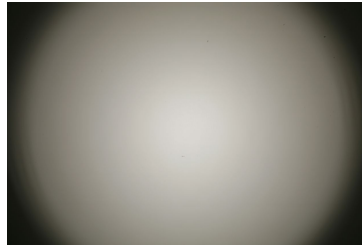

LED CXM-14
 FWHM 72.0°
 Efficiency 94 %
 Peak intensity 0.640 cd/lm
 Required components:
 BJB: 47.319.2021

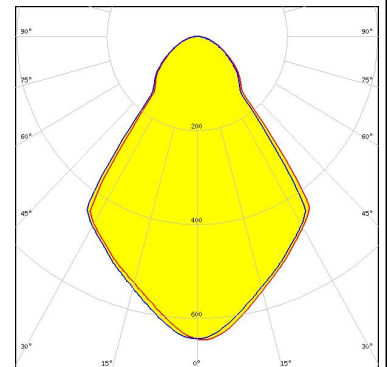
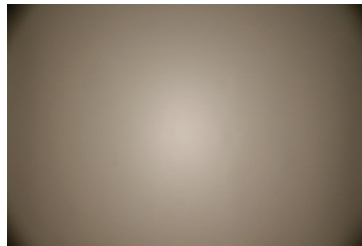

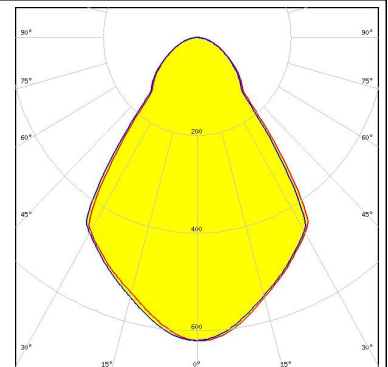
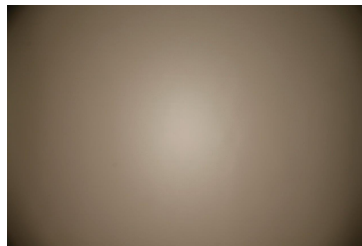

LED CXM-22
 FWHM 72.0°
 Efficiency 93 %
 Peak intensity 0.600 cd/lm
 Required components:
 BJB: 47.319.2030

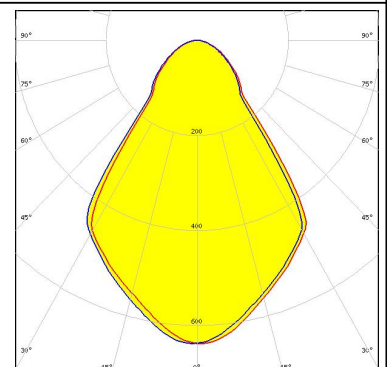

LED Soleriq E30
 FWHM 71.0°
 Efficiency 93 %
 Peak intensity 0.640 cd/lm
 Required components:
 BJB: 47.319.2090

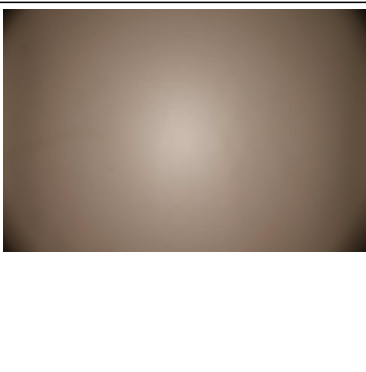
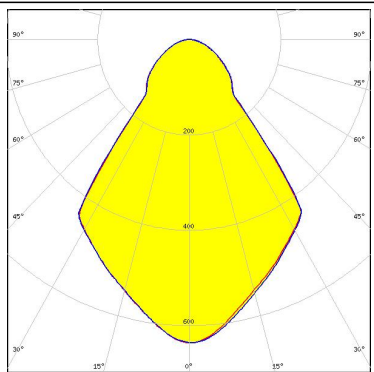

PHOTOMETRIC DATA (MEASURED):

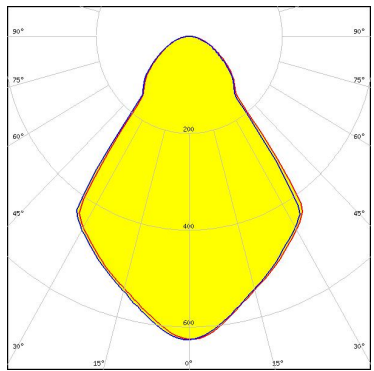
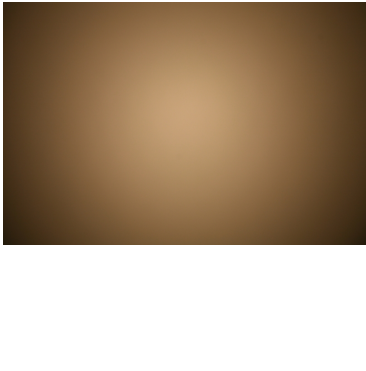
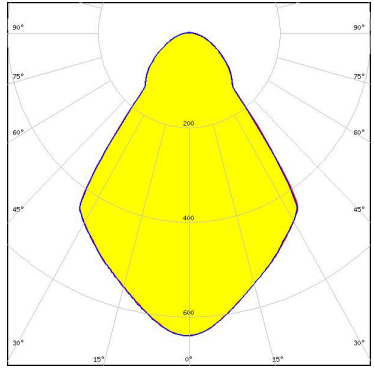
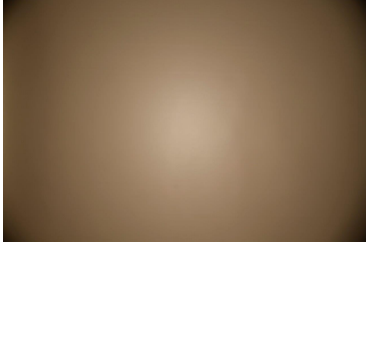
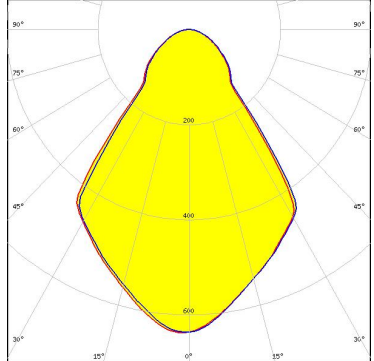
| | | |
|---|--|---|
| <p>OSRAM Opto Semiconductors</p> <p>LED Soleriq P13</p> <p>FWHM 73.0°</p> <p>Efficiency 94 %</p> <p>Peak intensity 0.640 cd/lm</p> <p>Required components: A.A.G. STUCCHI: 8502/G2</p> |  |  |
| <p>OSRAM Opto Semiconductors</p> <p>LED Soleriq S13 Gen2</p> <p>FWHM 73.0°</p> <p>Efficiency 93 %</p> <p>Peak intensity 0.630 cd/lm</p> <p>Required components: BJB: 47.319.2021</p> |  |  |
| <p>OSRAM Opto Semiconductors</p> <p>LED Soleriq S19</p> <p>FWHM 72.0°</p> <p>Efficiency 94 %</p> <p>Peak intensity 0.640 cd/lm</p> <p>Required components: BJB: 47.319.2170</p> |  |  |
| <p>OSRAM Opto Semiconductors</p> <p>LED Soleriq S19</p> <p>FWHM 72.0°</p> <p>Efficiency 93 %</p> <p>Peak intensity 0.640 cd/lm</p> <p>Required components: A.A.G. STUCCHI: 8503/G2</p> |  |  |

PHOTOMETRIC DATA (MEASURED):

SAMSUNG

LED COB D Series LES 14.5 mm
FWHM 73.0°
Efficiency 89 %
Peak intensity 0.600 cd/lm
Required components:
F13671_ANGE-RZ-LENS
A.A.G. STUCCHI: 8101/G2

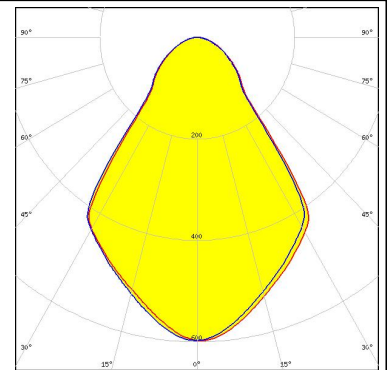

SAMSUNG

LED COB D Series LES 14.5 mm
FWHM 73.0°
Efficiency 93 %
Peak intensity 0.640 cd/lm
Required components:
A.A.G. STUCCHI: 8101/G2

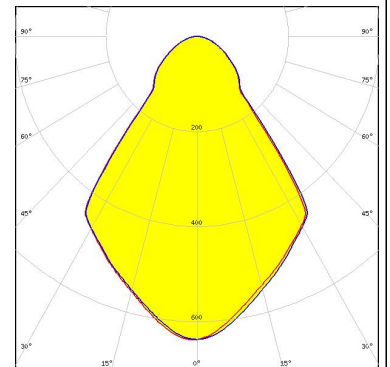
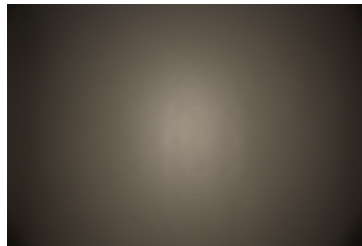

SAMSUNG

LED COB D Series LES 14.5 mm
FWHM 73.0°
Efficiency 89 %
Peak intensity 0.600 cd/lm
Required components:
F13671_ANGE-RZ-LENS
BJB: 47.319.2021

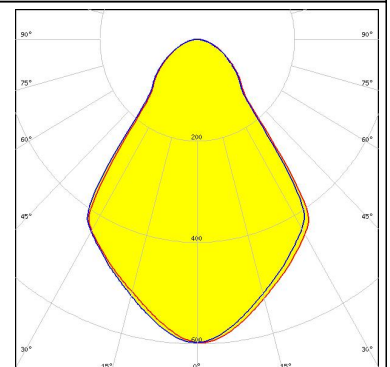
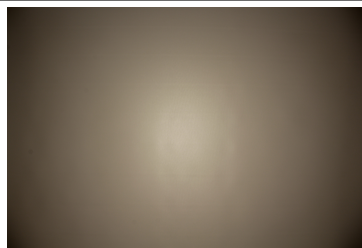

SEOUL SEMICONDUCTOR

LED ZC12/18
FWHM 72.0°
Efficiency 93 %
Peak intensity 0.660 cd/lm
Required components:
A.A.G. STUCCHI: 8101/G2

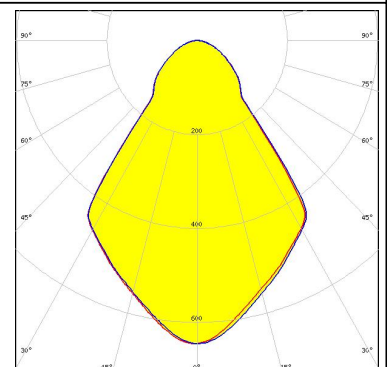
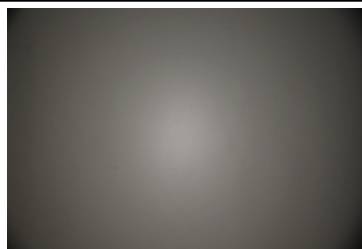

PHOTOMETRIC DATA (MEASURED):

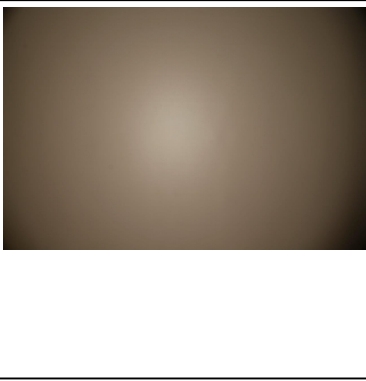
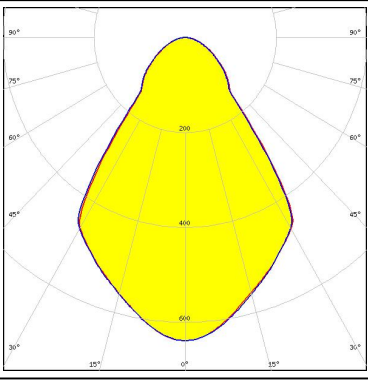
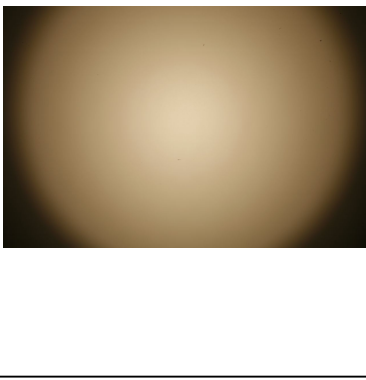
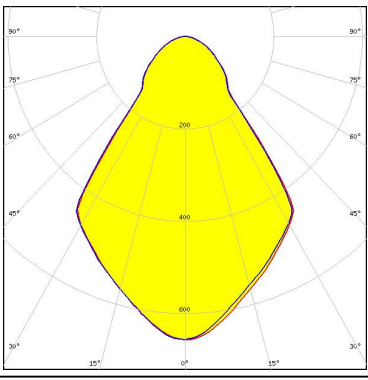
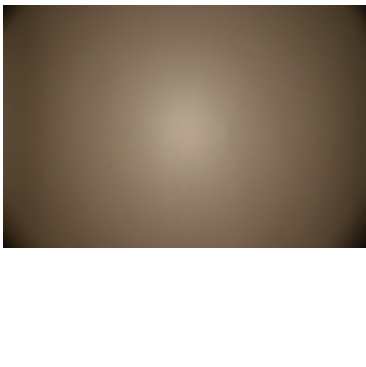
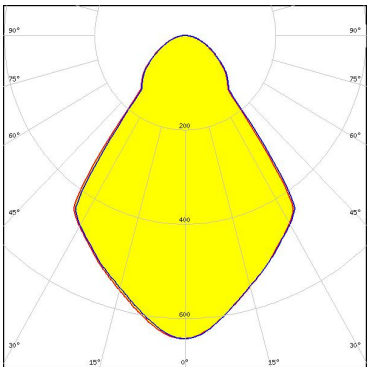
| | | |
|---|--|---|
| <p> SEOUL SEMICONDUCTOR</p> <p>LED ZC25/40/60 FWHM 71.0° Efficiency 93 % Peak intensity 0.640 cd/lm Required components: A.A.G. STUCCHI: 8102/G2</p> |  |  |
| <p>SHARP</p> <p>LED Mega Zenigata (GW6DME) FWHM 72.0° Efficiency 94 % Peak intensity 0.700 cd/lm Required components: BJB: 47.319.2011</p> |  |  |
| <p>SHARP</p> <p>LED Mega Zenigata (GW6DME) FWHM 73.0° Efficiency 94 % Peak intensity 0.640 cd/lm Required components: A.A.G. STUCCHI: 8301/G2</p> |  |  |

PHOTOMETRIC DATA (SIMULATED):

CITIZEN

LED CLU730/731
FWHM 70.0°
Efficiency 90 %
Peak intensity 0.766 cd/lm
Required components:
BJB: 47.319.2030

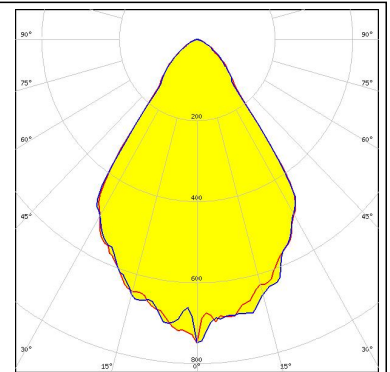

OSRAM

Opto Semiconductors
LED Soleriq S15
FWHM 72.0°
Efficiency 86 %
Peak intensity 0.610 cd/lm
Required components:
BJB: 47.319.2021

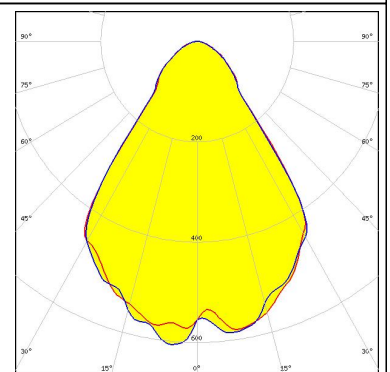

SAMSUNG

LED COB D Series LES 22 mm
FWHM 71.0°
Efficiency 85 %
Peak intensity 0.640 cd/lm
Required components:
BJB: 47.319.2030

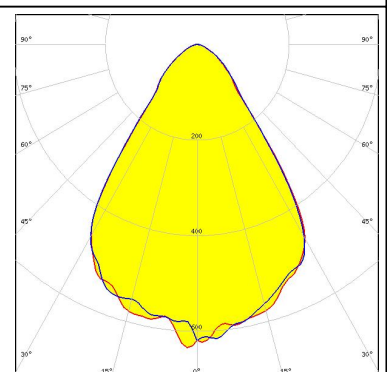

GENERAL INFORMATION:

NOTE: The typical beam angle will be changed by different color, chip size and chip position tolerance. The typical total beam angle is the full angle measured where the luminous intensity is half of the peak value.

Due to use of high power COB's with this product, special attention to proper thermal design is highly recommended. LEDiL has no liability for direct, indirect or consecutive damages arising from the LEDiL products being used outside of the recommended temperature range.

MATERIALS:

As part of our continuous research and improvement processes, and to ensure the best possible quality and availability of our products, LEDiL reserves the right to change material grades without notice.

PRODUCT DATA USER AGREEMENT AND DISCLAIMER:

The measured data in the provided downloadable LEDiL Product Datasheets and Mechanical 2D-Drawings is rounded and provided as reference for planning. LEDiL Oy's optical specifications have been verified by conducting performance testing of the products in accordance with the company's quality system. The reported data are averaged results of multiple measurements with typical variation. LEDiL Oy reserves the right to without prior notification make changes and improvements to its products.

LEDiL Oy assumes neither warranty, nor guarantee nor any other liability of any kind for the contents and correctness of the provided data. The provided data has been generated with highest diligence but the provided data may in reality not represent the complete possible variation range of all intrinsic parameters. Therefore, in certain cases a deviation from the provided data could occur.

LEDiL Oy reserves the right to undertake technical changes of its products without further notification which could lead to changes in the provided data. LEDiL Oy assumes no liability of any kind for the possible deviation from any provided data or any other damage resulting from the usage of the provided data.

The user agrees to this disclaimer and user agreement with the download or usage of the provided files.

LEDiL Oy

Joensuunkatu 13
FI-24240 SALO
Finland

LEDiL Inc.

228 West Page Street
Suite D
Sycamore IL 60178
USA

Local sales and technical support

www.ledil.com/where_to_buy

Shipping locations

Salo, Finland
Hong Kong, China

Distribution Partners

www.ledil.com/where_to_buy