

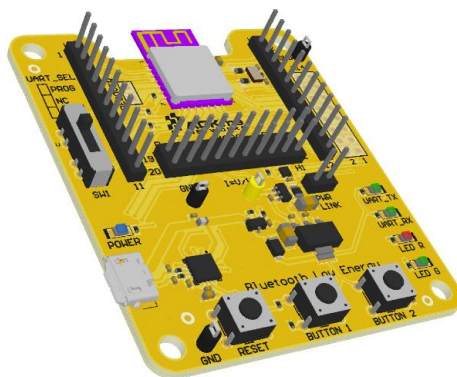

AMS00x-E03 Evaluation Guide



AMS001-E03
'Bream'

Disclaimer

While the information provided in this document is believed to be accurate, it is under development and ACKme Networks reserves the right to make changes without further notice to the product described herein to improve reliability, function, or design, and makes no guarantee or warranty concerning the accuracy of said information, nor shall it be responsible for any loss or damage of whatever nature resulting from the use of, or reliance upon, such information. ACKme Networks makes no warranties of any kind, whether express, implied or arising by custom or course of trade or performance, and specifically disclaims the implied warranties of title, non-infringement, merchantability, or fitness for a particular purpose.

No part of this document may be copied, reproduced, stored in a retrieval system, or transmitted, in any form or by any means, electronic, mechanical, photographic, or otherwise, or used as the basis for manufacture or sale of any items without the prior written consent of ACKme Networks.

Trademarks

ACKme Networks and the ACKme Networks logo are trademarks of ACKme Networks. WICED™ is a trademark of Broadcom® Corporation, Inc. Other trademarks in this document belong to their respective owners.

©2014-2015 ACKme Networks Inc.

All rights reserved.

Document Number: ARG-AMS00x-E03

Release Date: September 30, 2015

Contact

<http://ack.me/contact>

About this User Guide

This guide provides information and basic usage instructions for the TruConnect serial Bluetooth Low Energy application and the family of AMS001/AMS002 'Bobcat' modules available from ACKme Networks.

Evaluation boards covered by this guide include:

- AMS001-E03 'Bream'

Further information about TruConnect is available in the TruConnect Reference manual online at:

<http://truconnect.ack.me>

Organization

This document is organized into the following sections:

- [Introduction](#)
- [Feature Identification](#)
- [Using TruConnect](#)
- [Ordering Information](#)
- [Revision History & Glossary](#)
- [Appendix A – Setting up a Terminal Emulator](#)
- [Appendix B – Evaluation Board Schematics](#)

Contents

1	Introduction	1
2	Feature Identification	2
2.1	AMS001-E0x 'Bream'	2
2.2	Power Supply	3
2.2.1	Current Measurement	3
2.3	UART Selection	3
3	Using TruConnect with Bobcat & Bream	4
3.1	Getting Help.....	4
3.2	Listing TruConnect Variables	5
3.3	Scanning for Bluetooth Peripherals.....	5
3.4	Connecting to a Peripheral	5
3.5	Advertising as a Peripheral	5
3.6	Using GPIOs	6
3.7	Save and Reboot.....	6
3.8	Save Factory Settings.....	7
3.9	Factory Reset	7
3.10	Command vs. Stream Mode	7
3.10.1	Command Mode	7
3.10.2	Stream Mode	8
3.11	Want more?.....	8
4	Ordering Information.....	9
5	Revision History & Glossary	10
5.1	Revision History	10
5.2	Glossary	10

APPENDIX A – Configuring a Terminal Application

APPENDIX B – Evaluation Board Schematics

1 Introduction

The 'Bobcat' family of Bluetooth Low Energy modules are fully certified small form factor, low power modules perfectly suited to deeply embedded wireless applications requiring low-power and low-cost in medium to high volume.

Each module runs a fully-licensed version of TruConnect™, ACKme Networks' easy-to-use and reliable serial Bluetooth Low Energy application that provides a secure point-point wireless connection, rich peripheral interface and various BLE profiles for wireless sensors and related products requiring Bluetooth Low Energy.

Evaluation of TruConnect and the Bobcat family of modules is available with the AMS00x-E03 'Bream' evaluation board. The evaluation board is shown in Figure 1 and its features are listed in Table 1.

Figure 1. AMS00x-E03 Bream

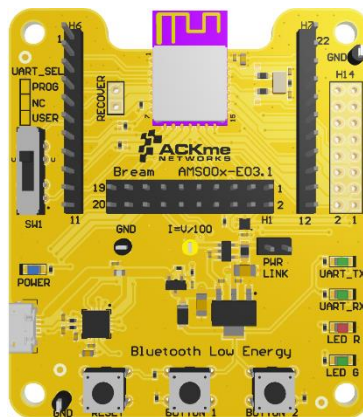

AMS001-E03 'Bream'

Table 1. AMS00x Evaluation Board Features

Feature	AMS00x-E03 'Bream'
Product Number	AMS00x-E03
Module style	Surface mount
Serial Interface for comms and programming	USB-UART
Power supply options	USB +5V with current monitor
User LEDs	1 Red LED, 1 Green LED
User Buttons	2
Reset Button	Yes
Peripheral Header	3.3V UART, I2C, Power
Breakout Headers	2 x 11-pin
Isolation Header	2 x 10-pin

2 Feature Identification

2.1 AMS001-E0x 'Bream'

The Bream evaluation board comes complete with a surface mount AMS001 (or AMS002) 'Bobcat' module. Each pin on the Bobcat module is connected to the expansion header. Schematics for the board are provided in Appendix B.

Figure 2. AMS001-E0x Features (TOP)

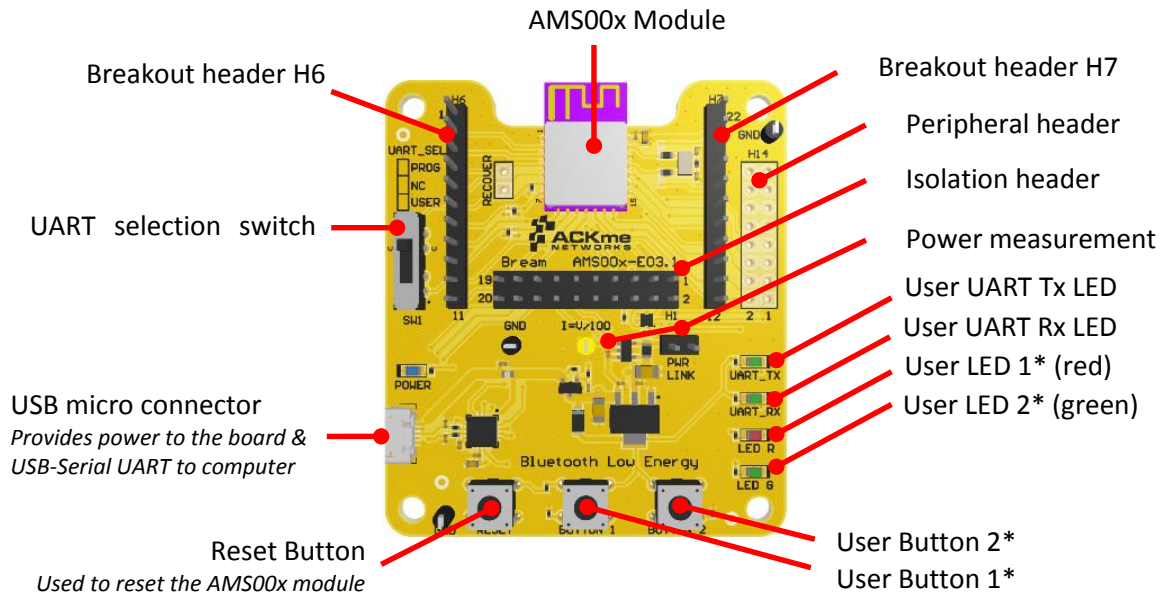

* User configurable

Table 2. AMS001-E03 Expansion Header Connections

AMS00x	H6	AMS00x	H7	AMS00x	H14	AMS00x	H14
GND	1	GPIO 7	12	USER_RTS	1	GPIO 11	11
PROG_RX	2	GPIO 8	13	GPIO 7	2	LED 1	12
PROG_TX	3	GPIO 9	14	USER_RX	3	GPIO 12	13
GPIO 0	4	GPIO 10	15	GPIO 10	4	LED 2	14
GPIO 1	5	GPIO 11	16	USER_TX	5	RESET_N	15
GPIO 2	6	GPIO 12	17	I2C_SCL	6	RESET_BTN	16
GPIO 3	7	GPIO 13	18	USER_CTS	7	GPIO 6	17
RESET_N	8	GND	19	UART_RTS_USB	8	BUTTON 1	18
GPIO 4	9	GPIO 14	20	GPIO 3	9	GPIO 9	19
GPIO 5	10	VDD_DUT	21	UART_CTS_USB	10	BUTTON 2	20
GPIO 6	11	GND	22				

2.2 Power Supply

The board may be powered by various power sources listed in Table 3 .

Table 3. Bream Power Supply Sources

Power Supply Source	Notes
USB	+5V is supplied from the USB interface
External 3.3V	External supply connected between H7 Pin 21 (+3.3V) and H7 Pin 19 (GND)

2.2.1 Current Measurement

The Bream board has an integrated current measurement circuit enabling current measurement with sub-milliamp accuracy. To measure dynamic current, connect an oscilloscope to the yellow testhook labelled $I=V/100$ (the yellow testhook is located near the middle of the board). To calculate the current used by the module, divide the voltage measured by the oscilloscope by a factor of one hundred. For example, if the scope shows 1.1V, the current consumed by the module is 11mA.

The integrated current measurement circuit is NOT suitable for measuring current in the low micro-amp range. To measure ultra-low sleep currents, a suitable external ammeter should be placed in series with the AMS00x power supply by connecting the ammeter to the jumper marked PWR_LINK.

2.3 UART Selection

The Bobcat module has two UARTs: a User UART for normal operation and a Programming UART. The Programming UART is only used if the module requires a custom program or manual firmware upgrade. For most use cases, the UART_SEL switch should be configured to the position marked USER.

To completely disconnect the AMS00x UART pins, move the switch to the center position. This may be necessary to minimise current consumption in ultra-low power modes or if an external UART is connected to the expansion header.



Note! If the UART is completely disconnected, the AMS00x PROG_TX pin (pin 3) may require a weak pull-up to avoid excessive current consumption or unexpected wake from low power sleep mode.

3 Using TruConnect with Bobcat & Bream

The Bobcat module on the Bream evaluation board runs a licensed version of TruConnect, the flexible, easy-to-use and intuitive Bluetooth Low Energy application from ACKme.

To get started with TruConnect, place the AMS001-E01 UART_SEL switch into the USER position, plug the evaluation board into the USB port of the computer and open a terminal emulator as described in Appendix A. The USB cable provides the Bobcat module and evaluation board with power and a serial UART connection to the computer.

With the board connected to the computer, verify the green LED is blinking slowly. If the LED does not blink, check the UART switch is set to USER, then try re-plugging the USB cable, or try a different USB cable.

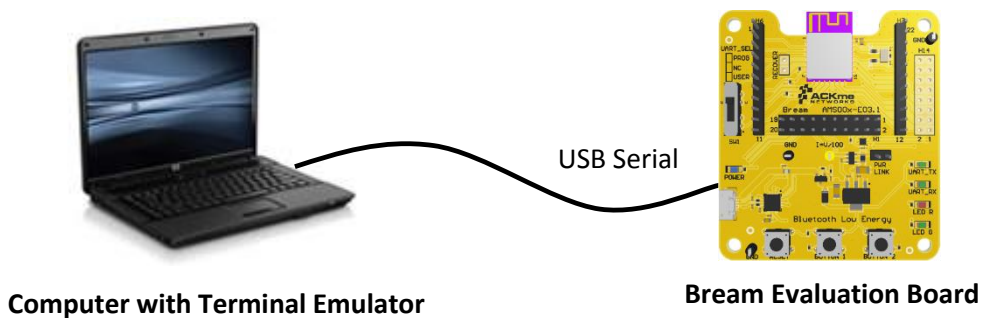

Note! The blue power LED illuminates when USB power is correctly supplied to the module. If the power LED is illuminated, but the module is still not working, ensure a jumper is in place on the 2-pin header marked PWR_LINK.

3.1 Getting Help

TruConnect help is available online at <http://truconnect.ack.me>

TruConnect operates in one of two serial bus modes: COMMAND mode, in which commands can be issued via a remote or UART serial interface, and STREAM mode, in which TruConnect does not respond to commands and instead passes characters to the Bluetooth wireless connection. The Bream platform is configured to boot TruConnect into COMMAND mode by default.

For more details on stream mode and command mode, see Section 3.10 Command vs. Stream Mode.

TruConnect is configured in human command mode by default, in this mode, TruConnect should respond to a carriage return with the following response:

```
Ready
>
```

If the response looks different, omitting the > characters for example, or characters entered into the terminal are not echoed, then TruConnect may be in machine command mode. To return TruConnect to human command mode for easy evaluation with a computer keyboard, enter the following commands:

```
> set sy c m human
> save
```

3.2 Listing TruConnect Variables

A list of all TruConnect variables is available by issuing the command: `get al`

```
> get al
bl a:      4C55CC10066F
bl c c:    0
bl s u:    175f8f23-a570-49bd-9627-815a6a27de2a
bl t a:    0
bl t c:    4
bl v m:    low
bl v h d:  30
bl v h i:  32
bl v l d:  300
bl v l i:  1024
bu i:      command
...
```

3.3 Scanning for Bluetooth Peripherals

To actively scan for any BLE peripheral in range using a high rate scan, use the `scan all high` command. Each device within range is listed on a separate line.

```
> scan all high
Success
! # RSSI BD_ADDR           Device Name
# 1  -59 4C:55:CC:12:9a:42 AMS-9A42
# 2  -78 B8:E8:56:49:9F:9A Apple TV
```

To scan only for ACKme BLE peripherals in range (with the ACKme service UUID configured by the variable `bl s u`), use the `scan high` command without the `all` argument. Each device within range is listed on a separate line.

```
> scan high
Success
! # RSSI BD_ADDR           Device Name
# 1  -59 20:73:7a:12:9a:42 AMS-9A42
```

Further information about the `scan` command is available online at <http://truconnect.ack.me/commands#scan>

3.4 Connecting to a Peripheral

To connect as a central to an ACKme BLE peripheral discovered during scanning, use the `con` command, with the index number listed by the results of `scan` as an argument, e.g. :

```
> con 1
Success
```

To disconnect from the peripheral, use the `det` command.

3.5 Advertising as a Peripheral

To make your ACKme BLE peripheral visible to other Bluetooth devices, use the `advertise` command:

```
> adv high
```

3.6 Using GPIOs

In TruConnect, pins on the Bobcat module may be configured to one of any number of functions including standard IO, status indicator, status GPIO, serial bus mode select, control GPIO and a number of others.

Before a pin can be used, it is first necessary to check whether the GPIO is already in use for another purpose.

Use the `get gp u` command to see a list of GPIO functions. For example:

```
> get gp u
! # Description
# 0 i2c_sda
# 1 i2c_scl
# 2 user_tx
# 3 none
# 4 none
# 5 user_rx
# 6 none,factory
# 7 reserved
# 8 none
# 9 mode_sel
# 10 status_led
# 11 none
# 12 none
# 13 speaker
# 14 stream_gpio
```

The example below demonstrates how to assign the mode select function to GPIO 9 on the Bobcat module, after first removing any previous function assigned to GPIO 9.

```
> gfu 9 none
Success
> gfu 9 mode_sel
Success
```

3.7 Save and Reboot

When the value of a TruConnect variable is changed, the new value is only saved to RAM (not flash!). The value of unsaved variables is lost when the module is reset or rebooted. To save variables to non-volatile flash memory, use the `save` command. The following example demonstrates that failing to `save` the variable value prior to reboot results in the newly assigned value being lost:

```
get sy r e
1
> set sy r e 0
Success
> get sy r e
0
> reboot
> get sy r e
1
> set sy r e 0
Success
> save
Success
> reboot
get sy r e
0
```



Note! TruConnect configures some services (such as GPIO initialization) only after reboot. It may be necessary to save and reboot the module before the new value of some variables takes effect.

3.8 Save Factory Settings

A custom factory configuration can be saved to non-volatile memory using the command:

```
save factory <BD_ADDR>
```

The <BD_ADDR> argument is required to ensure against accidental use of the command. To find the <BD_ADDR>, use the `get bl a` command.

If the factory settings are saved with the `lock` option, factory settings become permanent and may NEVER be overwritten. Be sure to double check factory settings are correct before locking down factory settings!

3.9 Factory Reset

The Bobcat module may be factory reset using the `fac` (factory reset) command or by holding the factory reset pin high for more than 10 seconds through a hardware reset. After a successful factory reset, all variables are set to factory defaults and the module reboots. To avoid accidental factory reset, the device BLE address must be provided when calling the `fac` command.

```
> get bl a
4C55CC10066F
> fac 4C55CC10066F
TruConnect-2.0.0.4, Built:Sep 11 2015 18:02:42, Module:AMS002.5, Board:AMS00x-E03.1
[COMMAND_MODE]
```

3.10 Command vs. Stream Mode

The TruConnect serial interface may be used in either Command Mode or Stream Mode. A brief description of each of these modes is provided in the following text. For detailed information, please refer to the [TruConnect Reference Guide](http://truconnect.ack.me) available online at <http://truconnect.ack.me>

3.10.1 Command Mode

Command mode provides an asynchronous command interface that a host may use to send and receive configuration information. Command mode is typically used by a host to configure TruConnect. All preceding examples demonstrate usage of TruConnect in command mode.

There are two ways to interact with TruConnect in command mode. When operating in human friendly command mode, TruConnect provides verbose asynchronous responses that are easy for humans to read. In machine friendly command mode, verbose prints and the command prompt are disabled and a well-defined response header is returned after each command.

Configuring Command Mode

Command mode can be configured using the convenience variable `sy c m` equivalent to `system.cmd.mode`

Command	Description
<code>set sy c m human</code>	Enable human friendly command mode
<code>set sy c m machine</code>	Enable machine friendly command mode

Setting `sy c m` executes a macro that sets the value of the four variables used to switch between human and command mode. These variables, together with the human and machine mode setting, are listed in the following table.

Command	Human	/	Machine	Description
<code>set sy p</code>	all	/	0	Set debug & informational print level
<code>set sy c h</code>	0	/	1	Disable/enable a response header
<code>set sy c p</code>	1	/	0	Turn on/off the user prompt
<code>set sy c e</code>	1	/	0	Turn on/off character echo. In human mode, lets you see what you're typing

Enabling and Disabling Command Mode

A device can issue commands to TruConnect locally via the UART serial interface, or remotely via a wireless connection. Only one device may have command mode access to TruConnect at any time.

A remote wireless device cannot place TruConnect in command mode when a local device is actively using the command interface. Similarly, a local device cannot use command mode if a remote device is actively using the command interface.

A local device or a remote device using TruConnect in command mode must put TruConnect into stream mode before another device is allowed can use command mode. Access to command mode from a remote device can be disabled with the `set sy r e 0` command (set remote enable off).

3.10.2 Stream Mode

Stream Mode provides a streaming interface that transparently connects the Bobcat UART serial interface with a remote device over a Bluetooth Low Energy wireless connection. Stream mode provides a simple 1-1 wireless connection between the physical serial interface and a remote BLE device.

A wireless serial port is a typical application that uses stream mode.

3.11 Want more?

The TruConnect Reference Guide, available online at <http://truconnect.ack.me>, provides detailed information about all TruConnect features, commands and variables, versions and release notes.

A number of simple and more sophisticated example applications are also provided to help you get the most out of TruConnect and the Bobcat family of Bluetooth Low Energy modules.

4 Ordering Information

Table 4 provides ordering information for AMS00x-E03 evaluation boards.

Table 4. Ordering Information

Part Number	Picture	Description
AMS00x-E03 'Bream'		TruConnect development and evaluation platform for the surface-mount AMS00x module. The surface mount AMS00x module is not removable.

5 Revision History & Glossary

5.1 Revision History

Table 5: Document Revision History

Revision	Date	Change Description
ARG-AMS00xE-100R	Sep 30, 2015	First release

5.2 Glossary

In most cases, acronyms and abbreviations are defined on first use. A comprehensive list of acronyms and other terms used in ACKme Networks documents are provided on the ACKme Networks website at <http://ack.me/FAQs/Glossary>.

APPENDIX A – Configuring a Terminal Application

The following instructions describe how to obtain and install a serial terminal application for use on computers running a Windows® or OS X operations system. ACKme recommends using Tera Term for Windows® systems and CoolTerm for OS X systems, however other equivalent applications may work equally well.

Plug the evaluation board into the computer using a USB cable before continuing.

Verify USB-Serial Driver Installation

The USB-Serial interface on TruConnect evaluation boards is based on an FTDI chip used widely in the industry. Most operating systems including Windows®, OS X, and Linux provide integrated FTDI driver support as part of the operating system. However on some older machines, or machines that do not pickup regular updates, the driver may not automatically install and it is necessary to manually install the driver.

On computers running Windows®, check if the driver is installed as follows:

- Display the System Control Panel (e.g. press the 'Windows' key + Pause key).
- In the left-hand column near the top of the panel, click **Device Manager**
- In the Device Manager dialog, expand the Ports (COM and LPT) branch
- FTDI drivers appear under the USB Serial Port items. If no items of this kind appear, the drivers may not be installed.
Note: The driver entry may not appear if the ACKme device is not connected to the USB port and powered on.
- Double click the USB Serial Port entry.
- Select the **General** tab in the USB Serial Port Properties dialog. Check the following:
 - Manufacturer: FTDI
 - Device status: This device is working properly
- Select the **Driver** tab in the USB Serial Port Properties dialog. Check the following:
 - Driver Provider: FTDI
 - Update drivers if necessary by clicking the **Update Driver...** button.
- In some cases, the FTDI driver may actually be correctly installed, but the driver may not enumerate as a Virtual Communications Port (VCP). If this is the case, find the device under the USB Serial Bus controllers section of the Device manager, open the device, check the VCP box, then click OK. It may be necessary to unplug/replug your evaluation board in order for the VCP driver to load correctly.

If the FTDI drivers do not appear to be installed, see the installation instructions on the FTDI official site:

<http://www.ftdichip.com/Support/Documents/InstallGuides.htm>

Set Up Tera Term for Windows®

Tera Term is available as a free download from <http://tssh2.sourceforge.jp>. Download and install Tera Term now if you have not already done so. The following procedure describes how to establish a UART serial connection between Tera Term and the evaluation board.

1. Start the Tera Term application and click on the **Setup** tab. A dropdown appears providing options to configure Tera Term as shown in the screen capture on the right. Select **Terminal**.
2. Terminal Setup. In the **New-line** section of the **Setup Terminal** dialog box (see the screen capture below), ensure that:
 - **Receive:** is set to **CR**
 - **Transmit:** is set to **CR+LF**

Close the **Terminal Setup** dialog box by selecting **OK**.

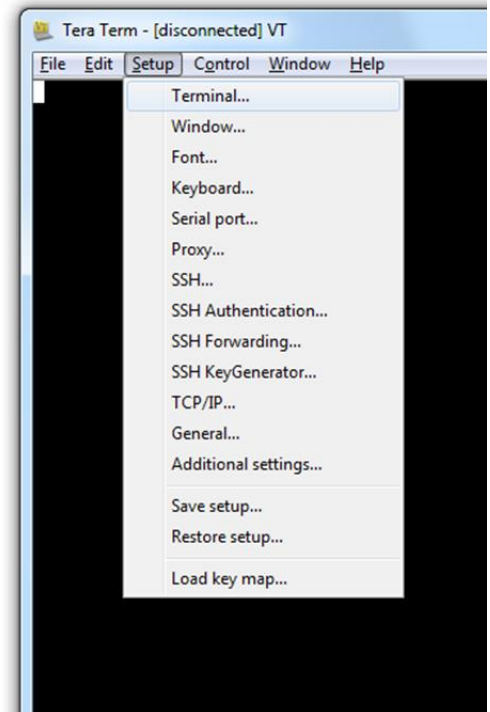
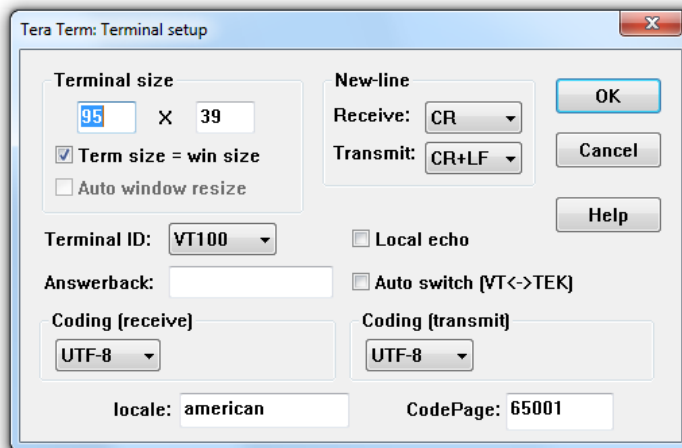

3. Serial Port Setup. Select the **Setup** tab again from the main window, then select **Serial port**. A **Setup serial port** dialog box appears. Ensure the settings in the dialog box match the settings shown in the following screen capture. The **COM Port** shown in the example (COM14) will almost certainly be different for your evaluation board, be sure to choose the COM port that matches your board.

When the serial port has been correctly setup, close the **Serial port** setup dialog box by selecting **OK**.

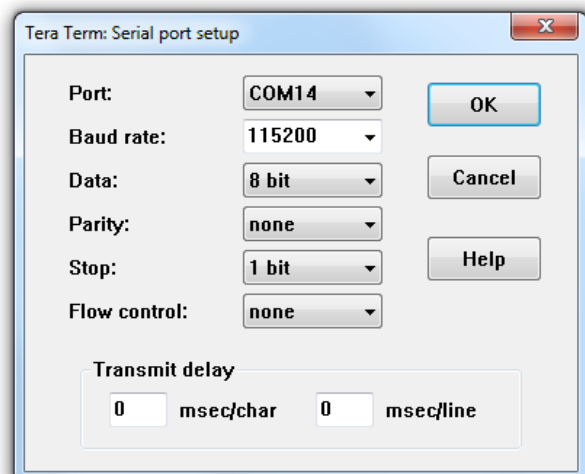

4. New Connection. From the Tera Term application menu, setup a new connection with the evaluation board by selecting **File | New connection** (or by pressing **Alt + N**) as shown in the screen capture on the right. A New connection dialog box appears as shown in the following screen capture. Check the **Serial** radio button, then click the **Port:** dropdown menu and select the COM port that matches your evaluation board. The COM port description for the evaluation board includes the text **COMxx: USB Serial Port (COMxx)**.

Once the correct COM port has been selected, close the **New connection** dialog box by selecting **OK**.

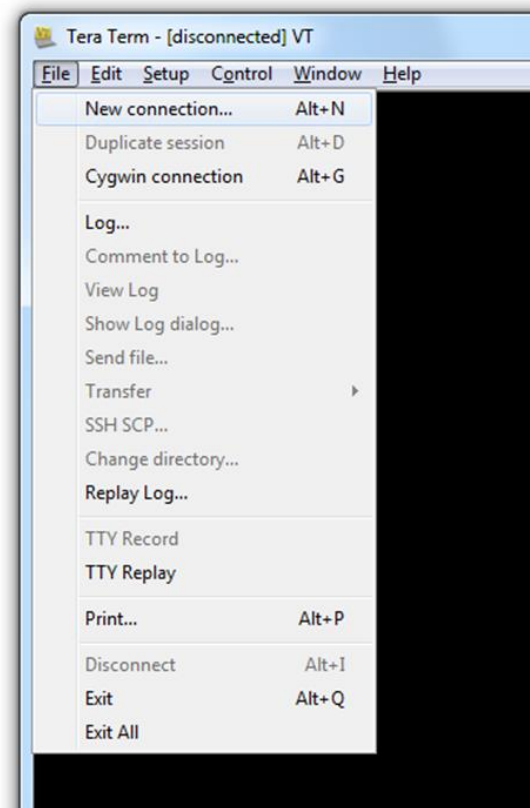
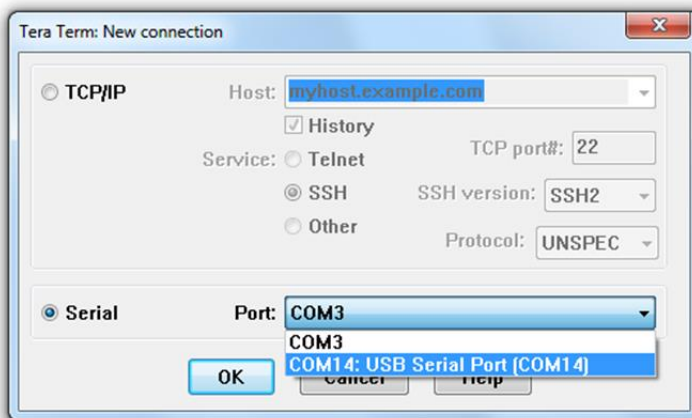

5. Testing the connection. If Tera Term was able to connect successfully, the text in the application title bar indicates which COM port is connected, and the baud rate of the connection. For the example documented above, Tera Term displays 'COM14:115200baud'. The Tera Term screen remains blank however until a character is sent to TruConnect. Try pressing the **Enter** key, TruConnect responds with `Ready` as shown in the following screen capture.

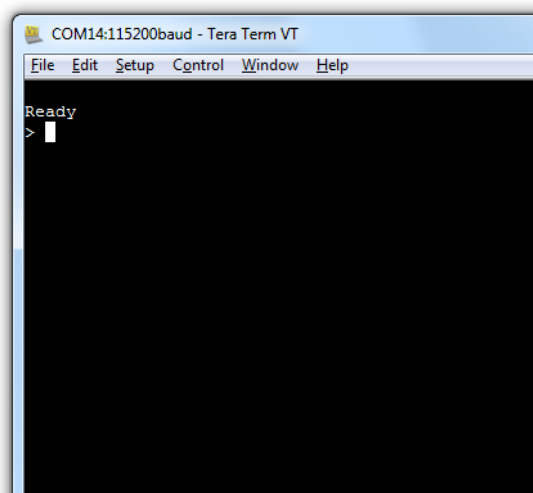

Set Up CoolTerm for OS X

CoolTerm is available as a free download from <http://freeware.the-meiers.org/CoolTermMac.zip>. Download and install CoolTerm now if you have not already done so.

The following procedure describes how to establish a UART serial interface between CoolTerm and the evaluation board.

1. Start the CoolTerm application and click the **Options** menu icon. The CoolTerm Configuration window opens. Set the Serial Port configuration options as follows:
 - Port: **usbserial-XXXXXXXX**
 - Baudrate: **115200**
 - Data bits: **8**
 - Parity: **none**
 - Stop bits: **1**
 - Flow control : Deselect all options
2. Click **OK**.
3. Click the **Connect** menu icon. The CoolTerm application connects to the evaluation board.

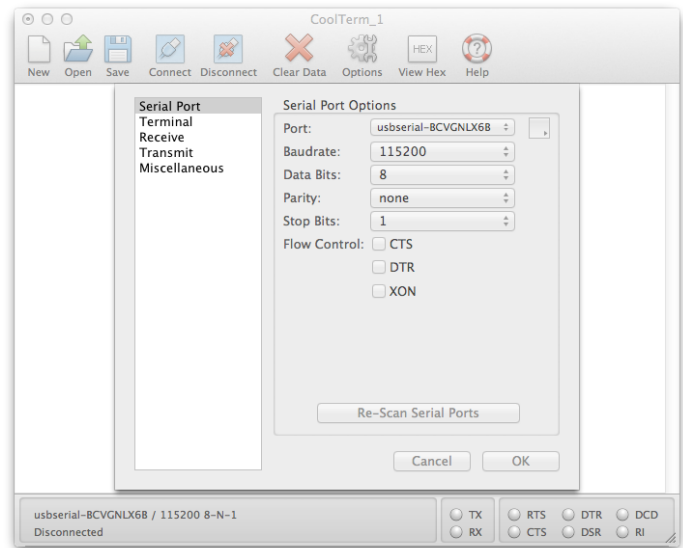

Try pressing the **Enter** key, if CoolTerm is successfully connected to the evaluation board, TruConnect responds with

```
Ready
>
```

Appendix B – Evaluation Board Schematics & Mechanical Dimensions

The schematic on this page is for Bream version 2 - AMS00x-E03.1. Schematics for other board revisions are available at <http://ack.me/resources/show>

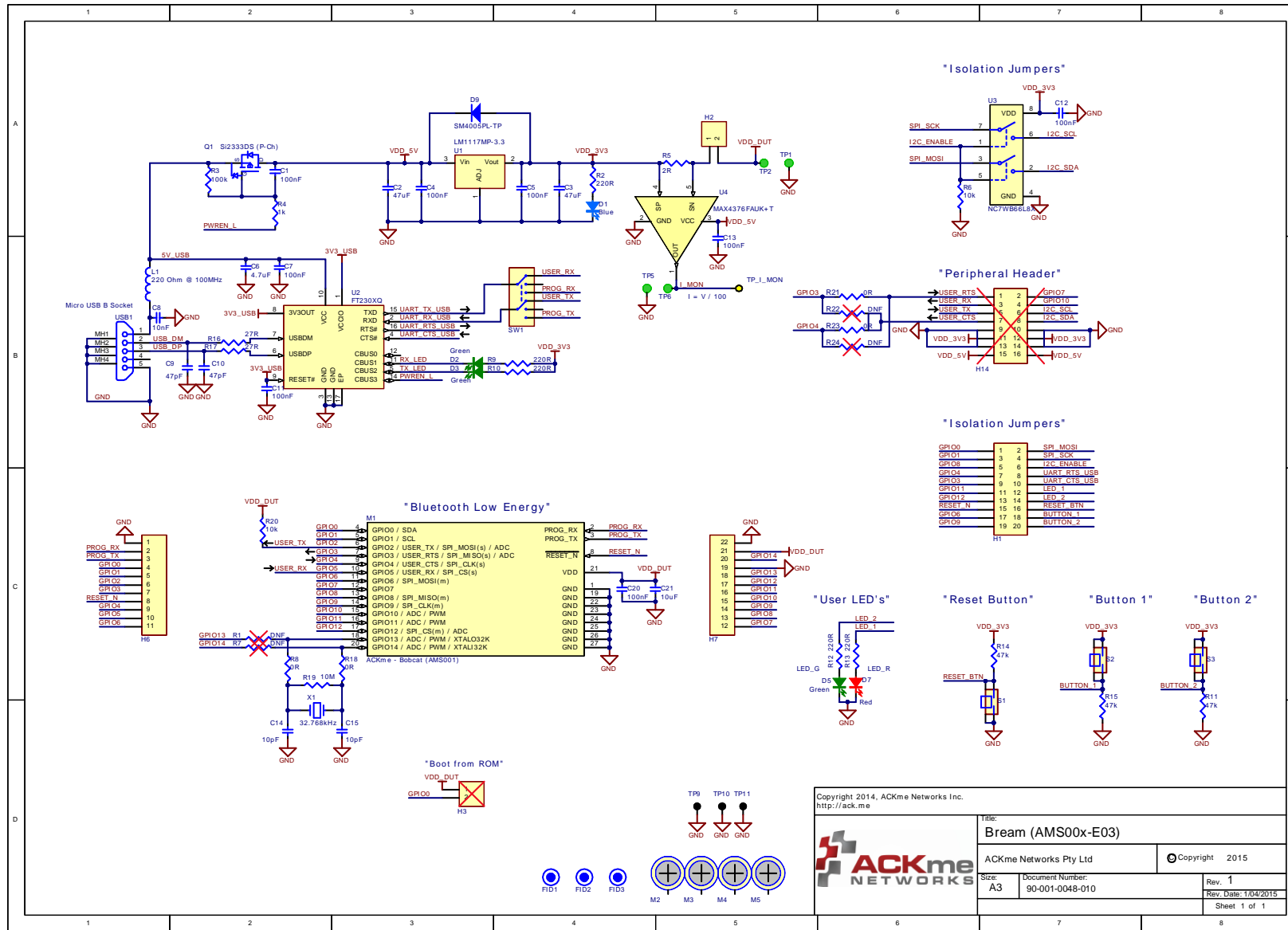

ACKme reserves the right to make changes without further notice to any products or data herein to improve reliability, function, or design. Information furnished by ACKme is believed to be accurate and reliable. However, ACKme does not assume any liability arising out of the application or use of this information, nor the application or use of any product described herein, neither does it convey any license under its patent rights nor the rights of others.

ACKme Networks

US Headquarters

20 North Santa Cruz Ave
Los Gatos CA 95030

©2014-2015 ACKme Networks Inc. All rights reserved.

ARG-AMS00x-E03-100R • AMS00x-E03 Evaluation Guide
September 30, 2015

Contact Information

+1 (408) 402 8601

<http://ack.me/contact>

