



Grayhill, Inc.

## 62S11-N5-060C

Numero di parte:

62S11-N5-060C

Costruttore / Marca:

Grayhill, Inc.

Descrizione del prodotto

ROTARY ENCODER OPTICAL 32PPR

Schede tecniche:

 62S11-N5-060C.pdf

Stato di RoHS

 Senza piombo / RoHS

Condizione di scorta

2164 pcs stock

Nave da

Hong Kong

Modo di spedizione

DHL/Fedex/TNT/UPS/EMS

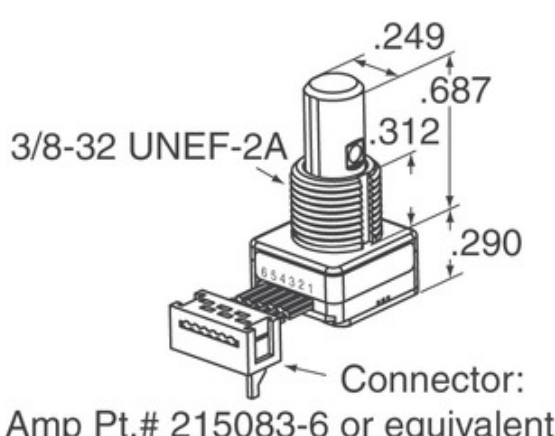

L'immagine può essere rappresentativa. Vedi le specifiche per i dettagli del prodotto.

[RICHIESTA DI OFFERTA](#)





### Specifiche di 62S11-N5-060C

NUMERO DI PARTE	62S11-N5-060C
FABBRICANTE	Grayhill, Inc.
DESCRIZIONE	ROTARY ENCODER OPTICAL 32PPR
STATO LEAD SENZA PIOMBO / ROHS	Senza piombo / RoHS
QUANTITÀ DISPONIBILE	2164 pcs
SCHEDA DATI	 62S11-N5-060C.pdf
TENSIONE DI ALIMENTAZIONE -	5V
STILE DI TERMINAZIONE	Cable with Connector
SERIE	62S
DURATA DI ROTAZIONE (CICLI AL MINUTO)	1M
IMPULSI PER GIRO	32
TIPO DI USCITA	Quadrature (Incremental)
ALTRI NOMI	62S11N5060C
ORIENTAMENTO	Vertical
TIPO MONTAGGIO	Panel Mount
MOISTURE SENSITIVITY LEVEL (MSL)	1 (Unlimited)
STATO SENZA PIOMBO / STATO ROHS	Lead free / RoHS Compliant
TIPO DI CODIFICATORE	Optical
ARRESTO	No
INTERRUTTORE INTEGRATO	Yes
TIPO DI ATTUATORE	1/4" Dia Flatted End

### Tag correlati

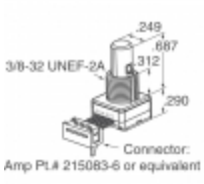
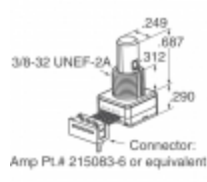
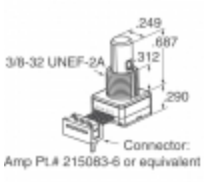
Grayhill, Inc. 62S11-N5-060C	Distributore 62S11-N5-060C	Fornitore 62S11-N5-060C
Prezzo 62S11-N5-060C	Immagini 62S11-N5-060C	Immagine 62S11-N5-060C
Scheda tecnica 62S11-N5-060C PDF	62S11-N5-060C Scarica la scheda tecnica	Datasheet 62S11-N5-060C
Azione 62S11-N5-060C	Acquista 62S11-N5-060C	Acquista Grayhill, Inc. 62S11-N5-060C
Grayhill, Inc. 62S11-N5-060C	Fornitore Grayhill, Inc.	Distributore Grayhill, Inc.
Grayhill, Inc. 62S11-N5-060C	Grayhill Inc. 62S11-N5-060C	

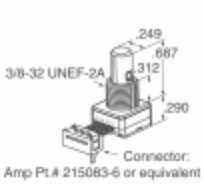
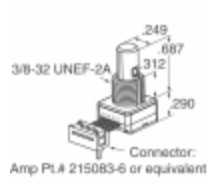
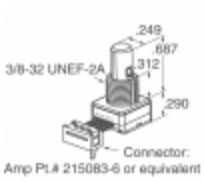
### prodotti correlati

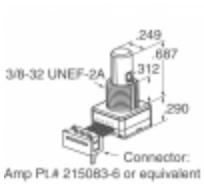
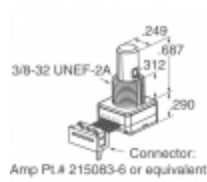
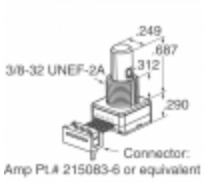
 <p><b>62S11-N5-025CH</b> Produttori: Grayhill, Inc. Descrizione: ROTARY ENCODER OPTICAL 32PPR disponibile: 2083 pcs</p> <p><a href="#">RFQ</a></p>	 <p><b>62S11-N5-P</b> Produttori: Grayhill, Inc. Descrizione: ROTARY ENCODER OPTICAL 32PPR disponibile: 1885 pcs</p> <p><a href="#">RFQ</a></p>
 <p><b>62S11-N5-040C</b> Produttori: Grayhill, Inc. Descrizione: ROTARY ENCODER OPTICAL 32PPR disponibile: 2106 pcs</p> <p><a href="#">RFQ</a></p>	 <p><b>62S11-N5-050C</b> Produttori: Grayhill, Inc. Descrizione: ROTARY ENCODER OPTICAL 32PPR disponibile: 1936 pcs</p> <p><a href="#">RFQ</a></p>
 <p><b>62S11-N5-PV</b> Produttori: Grayhill, Inc. Descrizione: ROTARY ENCODER OPTICAL 32PPR disponibile: 2220 pcs</p> <p><a href="#">RFQ</a></p>	 <p><b>62S11-N5-120S</b> Produttori: Grayhill, Inc. Descrizione: ROTARY ENCODER OPTICAL 32PPR disponibile: 1675 pcs</p> <p><a href="#">RFQ</a></p>
 <p><b>62S11-N5-080SH</b> Produttori: Grayhill, Inc. Descrizione: ROTARY ENCODER OPTICAL 32PPR disponibile: 1942 pcs</p> <p><a href="#">RFQ</a></p>	 <p><b>62S11-N4-PH</b> Produttori: Grayhill, Inc. Descrizione: ROTARY ENCODER OPTICAL 32PPR disponibile: 1970 pcs</p> <p><a href="#">RFQ</a></p>
 <p><b>62S11-N5-025C</b> Produttori: Grayhill, Inc. Descrizione: ROTARY ENCODER OPTICAL 32PPR disponibile: 2408 pcs</p> <p><a href="#">RFQ</a></p>	 <p><b>62S11-N4-P</b> Produttori: Grayhill, Inc. Descrizione: ROTARY ENCODER OPTICAL 32PPR disponibile: 1912 pcs</p> <p><a href="#">RFQ</a></p>
 <p><b>62S11-N5-100C</b> Produttori: Grayhill, Inc. Descrizione: ROTARY ENCODER OPTICAL 32PPR disponibile: 1789 pcs</p> <p><a href="#">RFQ</a></p>	 <p><b>62S11-N5-060SH</b> Produttori: Grayhill, Inc. Descrizione: ROTARY ENCODER OPTICAL 32PPR disponibile: 2263 pcs</p> <p><a href="#">RFQ</a></p>

Copyright © 2020 Distributore affidabile dei componenti elettronici

E-mail: [Info@infinity-electronic.com](mailto:Info@infinity-electronic.com)

Indirizzo: 17F, edificio commerciale Gaylord, 114-118 Lockhart Road, Wan Chai, Hong Kong

