



Grayhill, Inc.

## 62S11-N5-120S

Numero di parte:

62S11-N5-120S

Costruttore / Marca:

Grayhill, Inc.

Descrizione del prodotto

ROTARY ENCODER OPTICAL 32PPR

Schede tecniche:

 62S11-N5-120S.pdf

Stato di RoHS

 Senza piombo / RoHS

Condizione di scorta

1675 pcs stock

Nave da

Hong Kong

Modo di spedizione

DHL/Fedex/TNT/UPS/EMS

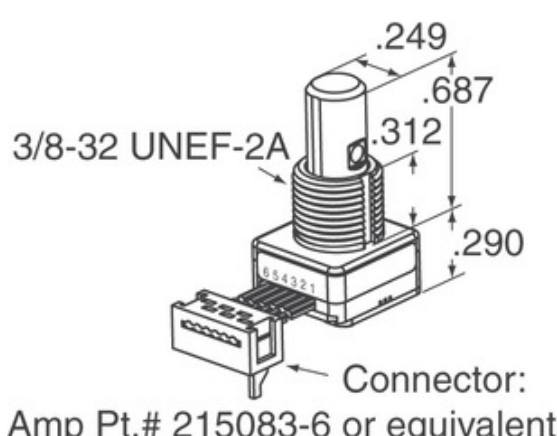

L'immagine può essere rappresentativa. Vedi le specifiche per i dettagli del prodotto.







### Specifiche di 62S11-N5-120S

NUMERO DI PARTE	62S11-N5-120S
FABBRICANTE	Grayhill, Inc.
DESCRIZIONE	ROTARY ENCODER OPTICAL 32PPR
STATO LEAD SENZA PIOMBO / ROHS	Senza piombo / RoHS
QUANTITÀ DISPONIBILE	1675 pcs
SCHEDA DATI	 62S11-N5-120S.pdf
TENSIONE DI ALIMENTAZIONE -	5V
STILE DI TERMINAZIONE	Cable Leads
SERIE	62S
DURATA DI ROTAZIONE (CICLI AL MINUTO)	1M
IMPULSI PER GIRO	32
TIPO DI USCITA	Quadrature (Incremental)
ALTRI NOMI	62S11N5120S
ORIENTAMENTO	Vertical
TIPO MONTAGGIO	Panel Mount
MOISTURE SENSITIVITY LEVEL (MSL)	1 (Unlimited)
STATO SENZA PIOMBO / STATO ROHS	Lead free / RoHS Compliant
TIPO DI CODIFICATORE	Optical
ARRESTO	No
INTERRUTTORE INTEGRATO	Yes
TIPO DI ATTUATORE	1/4" Dia Flatted End

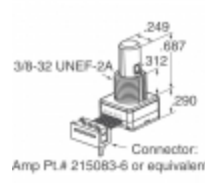
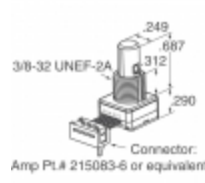
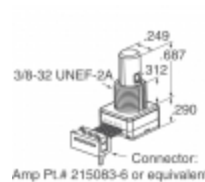
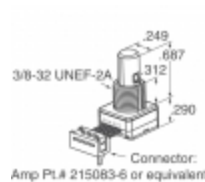
### Tag correlati

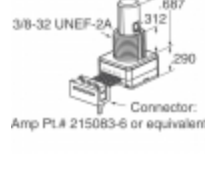
Grayhill, Inc. 62S11-N5-120S	Distributore 62S11-N5-120S	Fornitore 62S11-N5-120S
Prezzo 62S11-N5-120S	Immagini 62S11-N5-120S	Immagine 62S11-N5-120S
Scheda tecnica 62S11-N5-120S PDF	62S11-N5-120S Scarica la scheda tecnica	Datasheet 62S11-N5-120S
Azione 62S11-N5-120S	Acquista 62S11-N5-120S	Acquista Grayhill, Inc. 62S11-N5-120S
Grayhill, Inc. 62S11-N5-120S	Fornitore Grayhill, Inc.	Distributore Grayhill, Inc.
Grayhill, Inc. 62S11-N5-120S	Grayhill Inc. 62S11-N5-120S	

### prodotti correlati

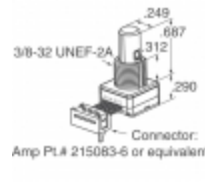
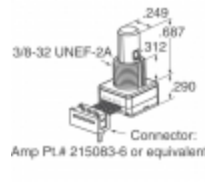
 <p><b>62S11-N9-060C</b> Produttori: Grayhill, Inc. Descrizione: ROTARY ENCODER OPTICAL 32PPR disponibile: 2192 pcs</p> <p><b>RFQ</b></p>	 <p><b>62S11-N5-040C</b> Produttori: Grayhill, Inc. Descrizione: ROTARY ENCODER OPTICAL 32PPR disponibile: 2106 pcs</p> <p><b>RFQ</b></p>
 <p><b>62S11-N9-PH</b> Produttori: Grayhill, Inc. Descrizione: ROTARY ENCODER OPTICAL 32PPR disponibile: 2219 pcs</p> <p><b>RFQ</b></p>	 <p><b>62S11-N5-060SH</b> Produttori: Grayhill, Inc. Descrizione: ROTARY ENCODER OPTICAL 32PPR disponibile: 2263 pcs</p> <p><b>RFQ</b></p>
 <p><b>62S11-N5-PV</b> Produttori: Grayhill, Inc. Descrizione: ROTARY ENCODER OPTICAL 32PPR disponibile: 2220 pcs</p> <p><b>RFQ</b></p>	 <p><b>62S11-N5-P</b> Produttori: Grayhill, Inc. Descrizione: ROTARY ENCODER OPTICAL 32PPR disponibile: 1885 pcs</p> <p><b>RFQ</b></p>
 <p><b>62S11-N5-050C</b> Produttori: Grayhill, Inc. Descrizione: ROTARY ENCODER OPTICAL 32PPR disponibile: 1936 pcs</p> <p><b>RFQ</b></p>	 <p><b>62S11-N5-080SH</b> Produttori: Grayhill, Inc. Descrizione: ROTARY ENCODER OPTICAL 32PPR disponibile: 1942 pcs</p> <p><b>RFQ</b></p>
 <p><b>62S11-N5-100C</b> Produttori: Grayhill, Inc. Descrizione: ROTARY ENCODER OPTICAL 32PPR disponibile: 1789 pcs</p> <p><b>RFQ</b></p>	 <p><b>62S11-N5-060C</b> Produttori: Grayhill, Inc. Descrizione: ROTARY ENCODER OPTICAL 32PPR disponibile: 2164 pcs</p> <p><b>RFQ</b></p>
 <p><b>62S11-N9-060SH</b> Produttori: Grayhill, Inc. Descrizione: ROTARY ENCODER OPTICAL 32PPR disponibile: 1801 pcs</p> <p><b>RFQ</b></p>	 <p><b>62S11-N9-120S</b> Produttori: Grayhill, Inc. Descrizione: ROTARY ENCODER OPTICAL 32PPR disponibile: 1784 pcs</p> <p><b>RFQ</b></p>

Copyright © 2020 Distributore affidabile dei componenti elettronici

E-mail: Info@infinity-electronic.com

Indirizzo: 17F, edificio commerciale Gaylord, 114-118 Lockhart Road, Wan Chai, Hong Kong

