



Grayhill, Inc.

## 62S11-L0-055C

Numero di parte:

62S11-L0-055C

Costruttore / Marca:

Grayhill, Inc.

Descrizione del prodotto

ROTARY ENCODER OPTICAL 32PPR

Schede tecniche:

 62S11-L0-055C.pdf

Stato di RoHS

 Senza piombo / RoHS

Condizione di scorta

1995 pcs stock

Nave da

Hong Kong

Modo di spedizione

DHL/Fedex/TNT/UPS/EMS

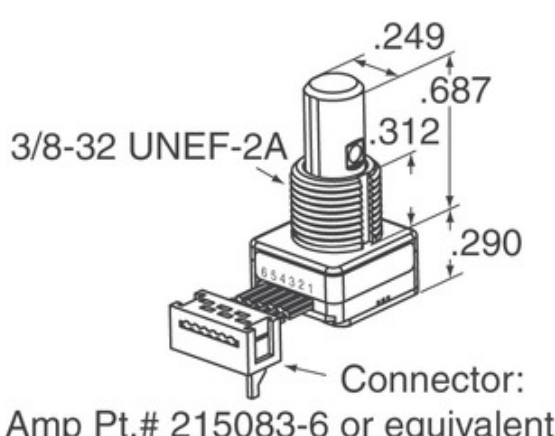

Connector:  
Amp Pt.# 215083-6 or equivalent

[RICHIESTA DI OFFERTA](#)

L'immagine può essere rappresentativa. Vedi le specifiche per i dettagli del prodotto.



### Specifiche di 62S11-L0-055C

NUMERO DI PARTE	62S11-L0-055C
FABBRICANTE	Grayhill, Inc.
DESCRIZIONE	ROTARY ENCODER OPTICAL 32PPR
STATO LEAD SENZA PIOMBO / ROHS	Senza piombo / RoHS
QUANTITÀ DISPONIBILE	1995 pcs
SCHEDA DATI	 62S11-L0-055C.pdf
TENSIONE DI ALIMENTAZIONE -	5V
STILE DI TERMINAZIONE	Cable with Connector
SERIE	62S
DURATA DI ROTAZIONE (CICLI AL MINUTO)	1M
IMPULSI PER GIRO	32
TIPO DI USCITA	Quadrature (Incremental)
ALTRI NOMI	62S11L0055C
ORIENTAMENTO	Vertical
TIPO MONTAGGIO	Panel Mount
MOISTURE SENSITIVITY LEVEL (MSL)	1 (Unlimited)
STATO SENZA PIOMBO / STATO ROHS	Lead free / RoHS Compliant
TIPO DI CODIFICATORE	Optical
ARRESTO	Yes
INTERRUTTORE INTEGRATO	No
TIPO DI ATTUATORE	1/4" Dia Flatted End

### Tag correlati

Grayhill, Inc. 62S11-L0-055C	Distributore 62S11-L0-055C	Fornitore 62S11-L0-055C
Prezzo 62S11-L0-055C	Immagini 62S11-L0-055C	Immagine 62S11-L0-055C
Scheda tecnica 62S11-L0-055C PDF	62S11-L0-055C Scarica la scheda tecnica	Datasheet 62S11-L0-055C
Azione 62S11-L0-055C	Acquista 62S11-L0-055C	Acquista Grayhill, Inc. 62S11-L0-055C
Grayhill, Inc. 62S11-L0-055C	Fornitore Grayhill, Inc.	Distributore Grayhill, Inc.
Grayhill, Inc. 62S11-L0-055C	Grayhill Inc. 62S11-L0-055C	

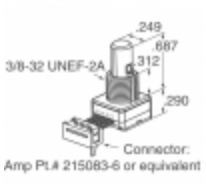
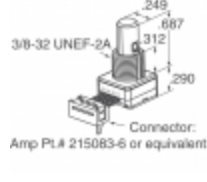
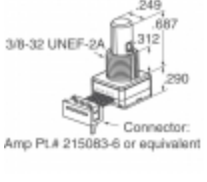
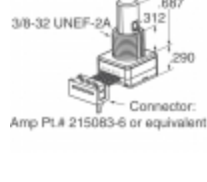
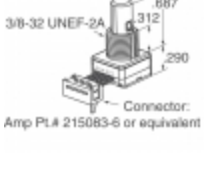
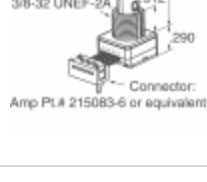
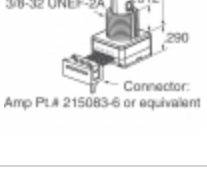
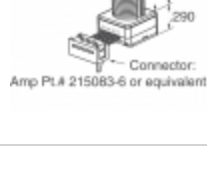
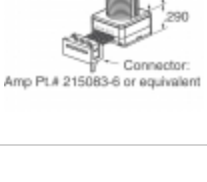
### prodotti correlati

 <p><b>62S11-L0-040S</b> Produttori: Grayhill, Inc. Descrizione: ROTARY ENCODER OPT 32PPR 4" CBL disponibile: 2058 pcs</p> <p><a href="#">RFQ</a></p>	 <p><b>62S11-L0-020C</b> Produttori: Grayhill, Inc. Descrizione: ROTARY ENCODER OPTICAL 32PPR disponibile: 1839 pcs</p> <p><a href="#">RFQ</a></p>
 <p><b>62S11-L0-040C</b> Produttori: Grayhill, Inc. Descrizione: ROTARY ENCODER OPTICAL 32PPR disponibile: 2079 pcs</p> <p><a href="#">RFQ</a></p>	 <p><b>62S11-L0-PHV</b> Produttori: Grayhill, Inc. Descrizione: ROTARY ENCODER OPTICAL 32PPR disponibile: 1991 pcs</p> <p><a href="#">RFQ</a></p>
 <p><b>62S11-L0-PH</b> Produttori: Grayhill, Inc. Descrizione: ROTARY ENCODER OPTICAL 32PPR disponibile: 2460 pcs</p> <p><a href="#">RFQ</a></p>	 <p><b>62S11-L0-060S</b> Produttori: Grayhill, Inc. Descrizione: ROTARY ENCODER OPTICAL 32PPR disponibile: 2241 pcs</p> <p><a href="#">RFQ</a></p>
 <p><b>62S11-L0-020CH</b> Produttori: Grayhill, Inc. Descrizione: ROTARY ENCODER OPTICAL 32PPR disponibile: 2105 pcs</p> <p><a href="#">RFQ</a></p>	 <p><b>62S11-L0-060CH</b> Produttori: Grayhill, Inc. Descrizione: ROTARY ENCODER OPTICAL 32PPR disponibile: 1935 pcs</p> <p><a href="#">RFQ</a></p>
 <p><b>62S11-H9-PH</b> Produttori: Grayhill, Inc. Descrizione: ROTARY ENCODER OPTICAL 32PPR disponibile: 2090 pcs</p> <p><a href="#">RFQ</a></p>	 <p><b>62S11-H9-P</b> Produttori: Grayhill, Inc. Descrizione: ROTARY ENCODER OPTICAL 32PPR disponibile: 2159 pcs</p> <p><a href="#">RFQ</a></p>
 <p><b>62S11-L0-060SH</b> Produttori: Grayhill, Inc. Descrizione: ROTARY ENCODER OPTICAL 32PPR disponibile: 2073 pcs</p> <p><a href="#">RFQ</a></p>	 <p><b>62S11-L0-P</b> Produttori: Grayhill, Inc. Descrizione: ROTARY ENCODER OPTICAL 32PPR disponibile: 2100 pcs</p> <p><a href="#">RFQ</a></p>

Copyright © 2020 Distributore affidabile dei componenti elettronici

E-mail: [Info@infinity-electronic.com](mailto:Info@infinity-electronic.com)

Indirizzo: 17F, edificio commerciale Gaylord, 114-118 Lockhart Road, Wan Chai, Hong Kong

