



BCM[®] Bus Converter BCM384y120x1K5AC1



Fixed Ratio DC-DC Converter

Features

- Up to 1500 W continuous output power
- 2208 W/in³ power density
- 97.4% peak efficiency
- 4242 Vdc isolation
- Parallel operation for multi-kW arrays
- OV, OC, UV, short circuit and thermal protection
- 2361 through-hole ChiP package
 - 2.402" x 0.990" x 0.286"
(61.00 mm x 25.14 mm x 7.26 mm)
- PMBus[™] management interface*

Typical Applications

- 380 DC Power Distribution
- High End Computing Systems
- Automated Test Equipment
- Industrial Systems
- High Density Power Supplies
- Communications Systems
- Transportation

Product Ratings	
$V_{IN} = 384 \text{ V (260 – 410 V)}$	$P_{OUT} = \text{up to 1500 W}$
$V_{OUT} = 12 \text{ V (8.1 – 12.8 V)}$ (NO LOAD)	$K = 1/32$

Product Description

The VI Chip[®] Bus Converter (BCM) is a high efficiency Sine Amplitude Converter (SAC), operating from a 260 to 410 VDC primary bus to deliver an isolated ratiometric output from 8.1 to 12.8 VDC.

The BCM384y120x1K5AC1 offers low noise, fast transient response, and industry leading efficiency and power density. In addition, it provides an AC impedance beyond the bandwidth of most downstream regulators, allowing input capacitance normally located at the input of a POL regulator to be located at the input of the BCM module. With a K factor of 1/32, that capacitance value can be reduced by a factor of 1024x, resulting in savings of board area, material and total system cost.

The BCM384y120x1K5AC1, combined with the D44TL1A0 Digital Supervisor and I13TL1A0 Digital Isolator, provide a secondary referenced PMBus[™] compatible telemetry and control interface. This interface provides access to the BCM's internal controller configuration, fault monitoring, and other telemetry functions.

Leveraging the thermal and density benefits of Vicor's ChiP packaging technology, the BCM module offers flexible thermal management options with very low top and bottom side thermal impedances. Thermally-adept ChiP-based power components, enable customers to achieve low cost power system solutions with previously unattainable system size, weight and efficiency attributes, quickly and predictably.

*When used with D44TL1A0 and I13TL1A0 chipset

Typical Application

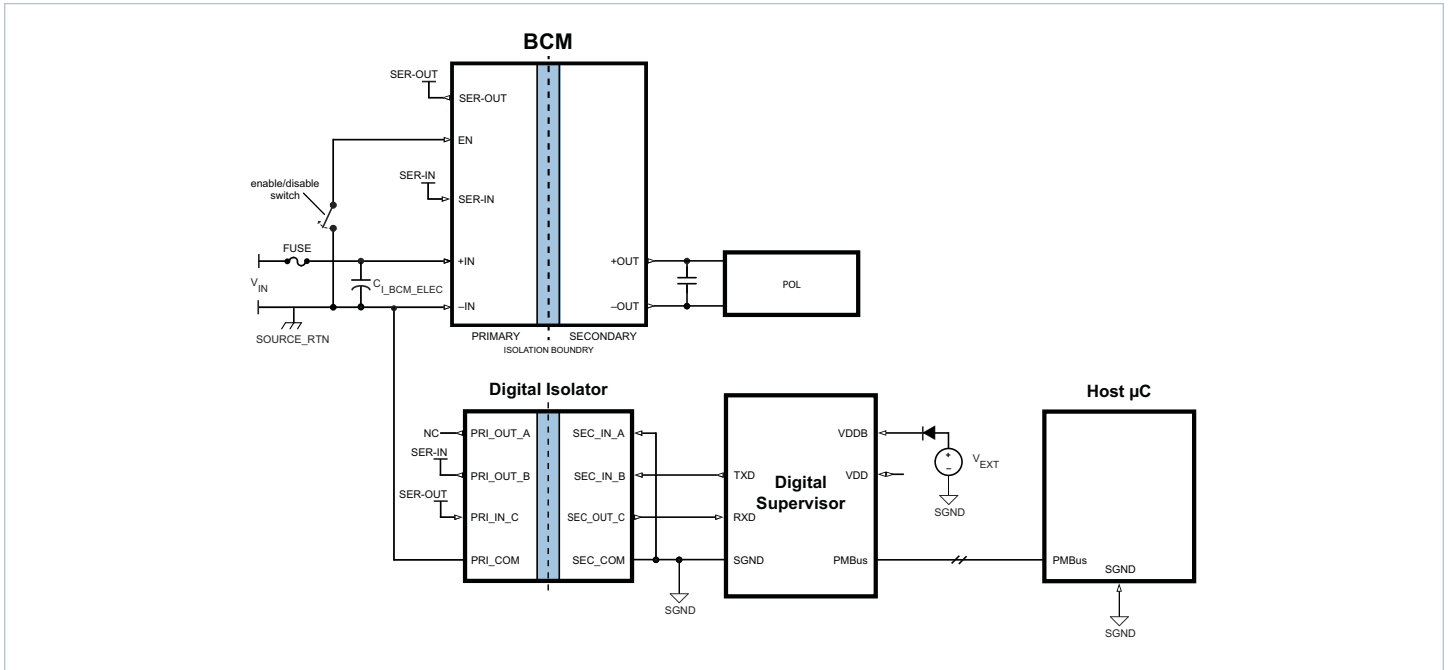

BCM384y120x1K5AC1 at point of load

Pin Configuration

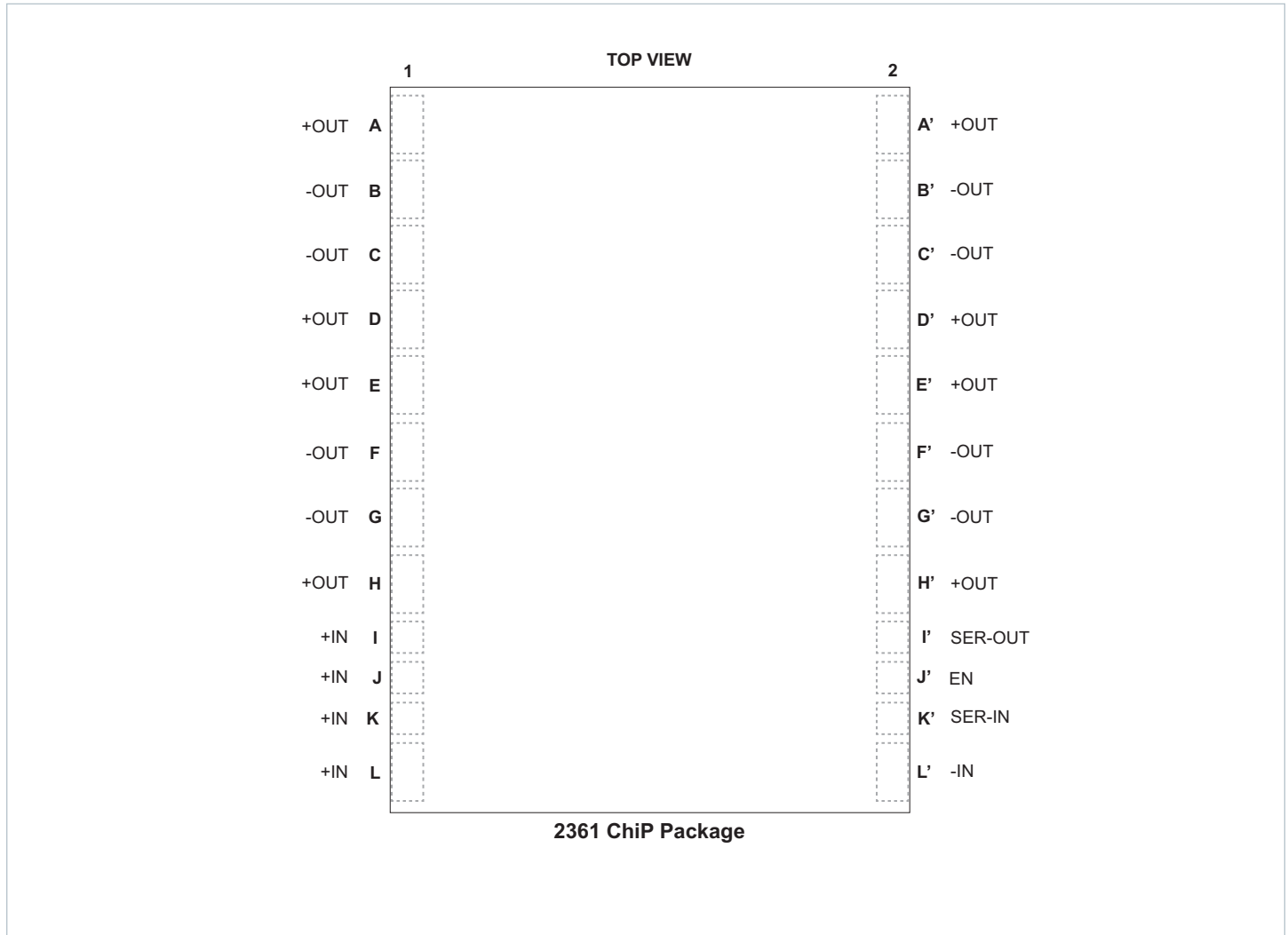

Pin Descriptions

Pin Number	Signal Name	Type	Function
I1, J1, K1, L1	+IN	INPUT POWER	Positive input power terminal
I'2	SER-OUT	OUTPUT	UART transmit pin; Primary side referenced signals
J'2	EN	INPUT	Enables and disables power supply; Primary side referenced signals
K'2	SER-IN	INPUT	UART receive pin; Primary side referenced signals
L'1	-IN	INPUT POWER RETURN	Negative input power terminal
A1, D1, E1, H1, A'2, D'2, E'2, H'2	+OUT	OUTPUT POWER	Positive output power terminal
B1, C1, F1, G1, B'2, C'2, F'2, G'2	-OUT	OUTPUT POWER RETURN	Negative output power terminal

Part Ordering Information

Device	Input Voltage Range	Package Type	Output Voltage x 10	Temperature Grade	Output Power	Revision	Package Size	Version
BCM	384	y	120	x	1K5	A	C	1
BCM = BCM	384 = 260 to 410 V	P = ChiP Through Hole	120 = 12 V	T = -40 to 125°C M = -55 to 125°C	1K5 = 1,500 W	A	C = 2361	1

All products shipped in JEDEC standard high profile (0.400" thick) trays (JEDEC Publication 95, Design Guide 4.10).

Standard Models

Part Number	V _{IN}	Package Type	V _{OUT}	Temperature	Power	Package Size
BCM384 P 120 T 1K5AC1	260 to 410 V	ChiP Through Hole	12 V 8.1 to 12.8 V	-40°C to 125°C	1,500 W	2361
BCM384 P 120 M 1K5AC1	260 to 410 V	ChiP Through Hole	12 V 8.1 to 12.8 V	-55°C to 125°C	1,500 W	2361

Absolute Maximum Ratings

The absolute maximum ratings below are stress ratings only. Operation at or beyond these maximum ratings can cause permanent damage to the device.

Parameter	Comments	Min	Max	Unit
+IN to -IN		-1	480	V
V _{IN} slew rate (operational)			1000	V/ms
Isolation voltage, input to output	Dielectric test applied to 100% production units		4242	V
+OUT to -OUT		-1	15	V
SER-OUT to -IN		-0.3	4.6	V
EN to -IN		-0.3	5.5	V
SER-IN to -IN		-0.3	4.6	V

Electrical Specifications

Specifications apply over all line and load conditions, unless otherwise noted; **Boldface** specifications apply over the temperature range of $-40^{\circ}\text{C} \leq T_{\text{INTERNAL}} \leq 125^{\circ}\text{C}$ (T-Grade); All other specifications are at $T_{\text{INTERNAL}} = 25^{\circ}\text{C}$ unless otherwise noted.

Attribute	Symbol	Conditions / Notes	Min	Typ	Max	Unit
Powertrain						
Input voltage range, continuous	$V_{\text{IN_DC}}$		260		410	V
Input voltage range, transient	$V_{\text{IN_TRANS}}$	Full current or power supported, 50 ms max, 10% duty cycle max	260		410	V
V_{IN} μ Controller Active	$V_{\mu\text{C_ACTIVE}}$	V_{IN} voltage where μC is initialized, (ie VAUX = Low, powertrain inactive)			130	V
Input Voltage Slew Rate	dV_{IN}/dt	$V_{\text{IN_UVLO-}} \leq V_{\text{IN}} \leq V_{\text{IN_OVLO+}}$	0.001		1000	V/ms
Quiescent current	I_{Q}	Disabled, EN Low, $V_{\text{IN}} = 384\text{ V}$ $T_{\text{INTERNAL}} \leq 100^{\circ}\text{C}$		2	4	mA
No load power dissipation	P_{NL}	$V_{\text{IN}} = 384\text{ V}$, $T_{\text{INTERNAL}} = 25^{\circ}\text{C}$		11	17	W
		$V_{\text{IN}} = 384\text{ V}$	5.9		25	
		$V_{\text{IN}} = 260\text{ V to }410\text{ V}$, $T_{\text{INTERNAL}} = 25^{\circ}\text{C}$			19	
		$V_{\text{IN}} = 260\text{ V to }410\text{ V}$			27	
Inrush current peak	$I_{\text{INR_P}}$	$V_{\text{IN}} = 410\text{ V}$, $C_{\text{OUT}} = 1000\ \mu\text{F}$, $R_{\text{LOAD}} = 25\%$ of full load current $T_{\text{INTERNAL}} \leq 100^{\circ}\text{C}$		10	15	A
DC input current	$I_{\text{IN_DC}}$	At $P_{\text{OUT}} = 1500\text{ W}$, $T_{\text{INTERNAL}} \leq 100^{\circ}\text{C}$			4.1	A
Transformation ratio	K	$K = V_{\text{OUT}}/V_{\text{IN}}$, at no load		1/32		V/V
Output power (continuous)	$P_{\text{OUT_DC}}$				1500	W
Output power (pulsed)	$P_{\text{OUT_PULSE}}$	10 ms pulse, 25% Duty cycle, $P_{\text{TOTAL}} = \% \text{ rated } P_{\text{OUT_DC}}$			2000	W
Output current (continuous)	$I_{\text{OUT_DC}}$				125	A
Output current (pulsed)	$I_{\text{OUT_PULSE}}$	10 ms pulse, 25% Duty cycle, $I_{\text{TOTAL}} = \% \text{ rated } I_{\text{OUT_DC}}$			167	A
Efficiency (ambient)	η_{AMB}	$V_{\text{IN}} = 384\text{ V}$, $I_{\text{OUT}} = 125\text{ A}$	96.2	97		%
		$V_{\text{IN}} = 260\text{ V to }410\text{ V}$, $I_{\text{OUT}} = 125\text{ A}$	95.2			
		$V_{\text{IN}} = 384\text{ V}$, $I_{\text{OUT}} = 62.5\text{ A}$	96.5	97.4		
Efficiency (hot)	η_{HOT}	$V_{\text{IN}} = 384\text{ V}$, $I_{\text{OUT}} = 125\text{ A}$, $T_{\text{INTERNAL}} = 100^{\circ}\text{C}$	95.8	97		%
Efficiency (over load range)	$\eta_{20\%}$	$25\text{ A} < I_{\text{OUT}} < 125\text{ A}$, $T_{\text{INTERNAL}} \leq 100^{\circ}\text{C}$	90			%
Output resistance	$R_{\text{OUT_COLD}}$	$V_{\text{IN}} = 384\text{ V}$, $I_{\text{OUT}} = 125\text{ A}$, $T_{\text{INTERNAL}} = -40^{\circ}\text{C}$	1.10	1.50	1.80	m Ω
	$R_{\text{OUT_AMB}}$	$V_{\text{IN}} = 384\text{ V}$, $I_{\text{OUT}} = 125\text{ A}$	1.50	1.85	2.30	
	$R_{\text{OUT_HOT}}$	$V_{\text{IN}} = 384\text{ V}$, $I_{\text{OUT}} = 125\text{ A}$, $T_{\text{INTERNAL}} = 100^{\circ}\text{C}$	1.80	2.30	2.70	
Switching frequency	F_{SW}	Frequency of the Output Voltage Ripple = $2x F_{\text{SW}}$	0.95	1.00	1.05	MHz
Output voltage ripple	$V_{\text{OUT_PP}}$	$C_{\text{OUT}} = 0\text{ F}$, $I_{\text{OUT}} = 125\text{ A}$, $V_{\text{IN}} = 384\text{ V}$, 20 MHz BW $T_{\text{INTERNAL}} \leq 100^{\circ}\text{C}$		195		mV
					250	
Input inductance (parasitic)	$L_{\text{IN_PAR}}$	Frequency 2.5 MHz (double switching frequency), Simulated lead model		7		nH
Output inductance (parasitic)	$L_{\text{OUT_PAR}}$	Frequency 2.5 MHz (double switching frequency), Simulated lead model		0.64		nH
Input Series inductance (internal)	$L_{\text{IN_INT}}$	Reduces the need for input decoupling inductance in BCM arrays		0.56		μH
Effective Input capacitance (internal)	$C_{\text{IN_INT}}$	Effective value at 384 V_{IN}		0.37		μF

Electrical Specifications (Cont.)

Specifications apply over all line and load conditions, unless otherwise noted; **Boldface** specifications apply over the temperature range of $-40^{\circ}\text{C} \leq T_{\text{INTERNAL}} \leq 125^{\circ}\text{C}$ (T-Grade); All other specifications are at $T_{\text{INTERNAL}} = 25^{\circ}\text{C}$ unless otherwise noted.

Attribute	Symbol	Conditions / Notes	Min	Typ	Max	Unit
Powertrain (Cont.)						
Effective Output capacitance (internal)	$C_{\text{OUT_INT}}$	Effective value at 12 V_{OUT}		208		μF
Effective Output capacitance (external)	$C_{\text{OUT_EXT}}$	Excessive capacitance may drive module into SC protection	0		1000	μF
Array Maximum external output capacitance	$C_{\text{OUT_AEXT}}$	$C_{\text{OUT_AEXT Max}} = N * 0.5 * C_{\text{OUT_EXT Max}}$				
Powertrain Protection						
Auto Restart Time	$t_{\text{AUTO_RESTART}}$	Startup into a persistent fault condition. Non-Latching fault detection given $V_{\text{IN}} > V_{\text{IN_UVLO+}}$. Module will ignore attempts to re-enable during time off	292.5		357.5	ms
Input overvoltage lockout threshold	$V_{\text{IN_OVLO+}}$		430	440	450	V
Input overvoltage recovery threshold	$V_{\text{IN_OVLO-}}$		410	430	440	V
Input overvoltage lockout hysteresis	$V_{\text{IN_OVLO_HYST}}$			10		V
Overvoltage lockout response time	t_{OVLO}			100		μs
Soft-Start time	$t_{\text{SOFT-START}}$	From powertrain active Fast Current limit protection disabled during Soft-Start		1		ms
Output overcurrent trip threshold	I_{OCP}		135	170	210	A
Overcurrent Response Time Constant	t_{OCP}	Effective internal RC filter		3.0		ms
Short circuit protection trip threshold	I_{SCP}		187			A
Short circuit protection response time	t_{SCP}			1		μs
Overtemperature shutdown threshold	t_{OTP}	Temperature sensor located inside controller IC	125			$^{\circ}\text{C}$
Powertrain Supervisory Limits						
Input overvoltage lockout threshold	$V_{\text{IN_OVLO+}}$		420	434.5	450	V
Input overvoltage recovery threshold	$V_{\text{IN_OVLO-}}$		405	424	440	V
Input overvoltage lockout hysteresis	$V_{\text{IN_OVLO_HYST}}$			10.5		V
Overvoltage lockout response time	t_{OVLO}			100		μs
Input undervoltage lockout threshold	$V_{\text{IN_UVLO-}}$		200	226	250	V
Input undervoltage recovery threshold	$V_{\text{IN_UVLO+}}$		225	244	259	V
Input undervoltage lockout hysteresis	$V_{\text{IN_UVLO_HYST}}$			15		V
Undervoltage lockout response time	t_{UVLO}			100		μs
Undervoltage startup delay	$t_{\text{UVLO+_DELAY}}$	From $V_{\text{IN}} = V_{\text{IN_UVLO+}}$ to powertrain active, EN floating, (i.e One time Startup delay from application of V_{IN} to V_{OUT})		20		ms
Output Overcurrent Trip Threshold	I_{OCP}		159	168	177	A
Overcurrent Response Time Constant	t_{OCP}			2		ms
Overtemperature shutdown threshold	t_{OTP}	Temperature sensor located inside controller IC	125			$^{\circ}\text{C}$
Undertemperature shutdown threshold	t_{UTP}	Temperature sensor located inside controller IC			-45	$^{\circ}\text{C}$
Undertemperature restart time	$t_{\text{UTP_RESTART}}$	Startup into a persistent fault condition. Non-Latching fault detection given $V_{\text{IN}} > V_{\text{IN_UVLO+}}$		3		s

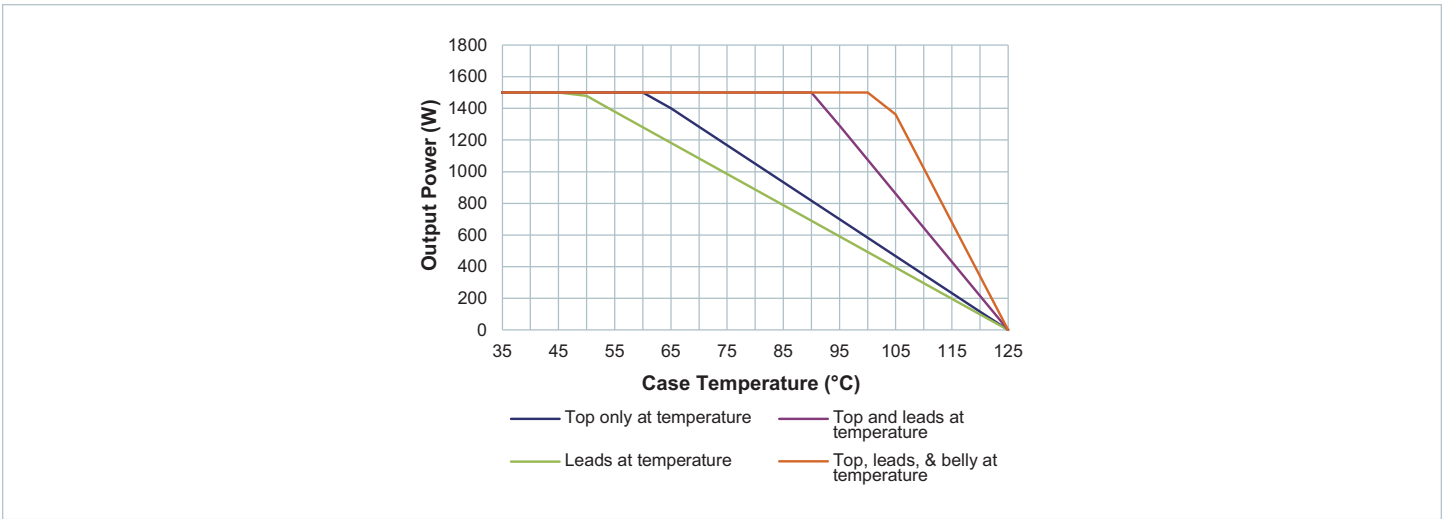

Figure 1 — Specified thermal operating area

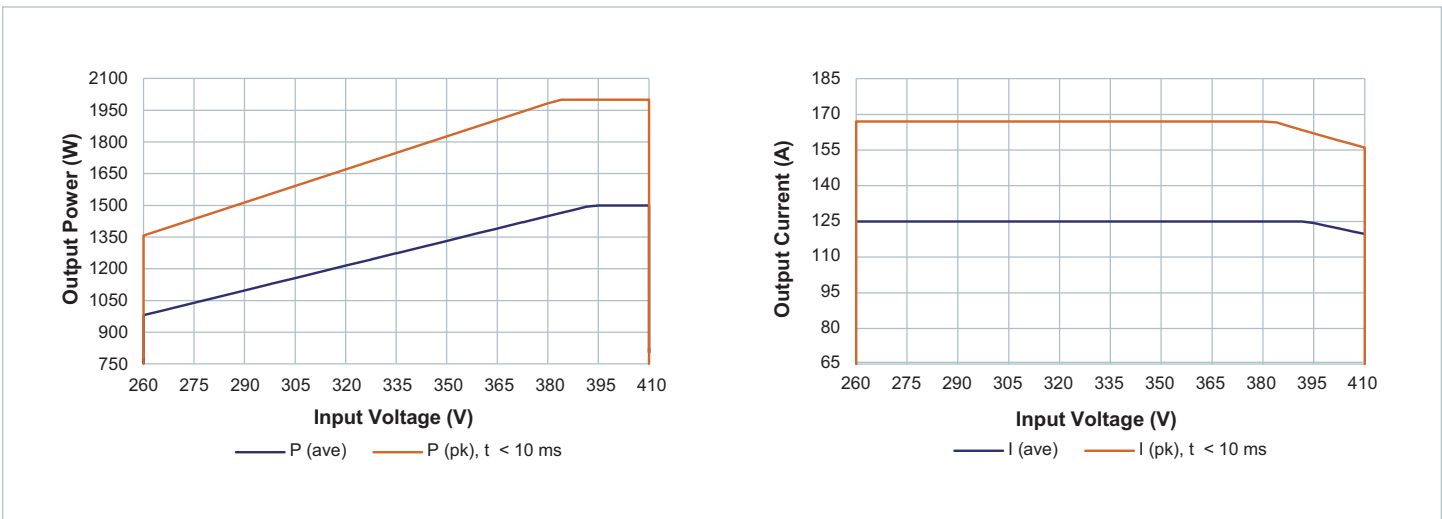

Figure 2 — Specified electrical operating area using rated R_{OUT_HOT}

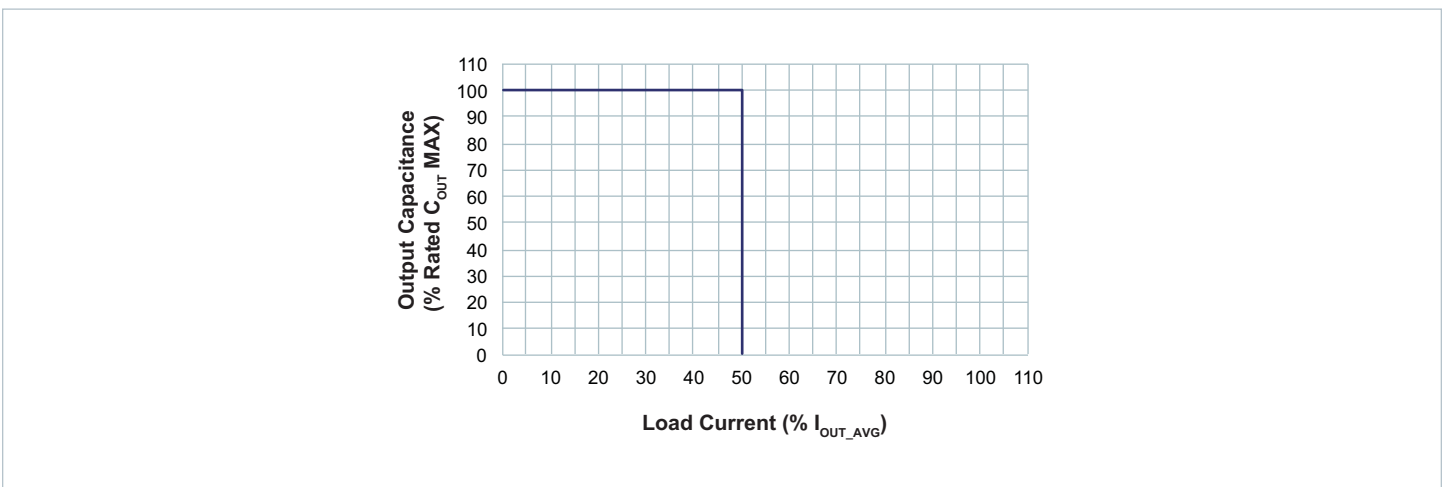

Figure 3 — Specified Primary start-up into load current and external capacitance

Reported Characteristics

Specifications apply over all line, load conditions, unless otherwise noted; **Boldface** specifications apply over the temperature range of $-40^{\circ}\text{C} \leq T_{\text{INTERNAL}} \leq 125^{\circ}\text{C}$ (T-Grade); All other specifications are at $T_{\text{INTERNAL}} = 25^{\circ}\text{C}$ unless otherwise noted.

Monitored Telemetry					
• The BCM communication version is not intended to be used without a Digital Supervisor.					
ATTRIBUTE	DIGITAL SUPERVISOR PMBus™ READ COMMAND	ACCURACY (RATED RANGE)	FUNCTIONAL REPORTING RANGE	UPDATE RATE	REPORTED UNITS
Input voltage	(88h) READ_VIN	$\pm 5\%$ (LL - HL)	130 V to 450 V	100 μs	$V_{\text{ACTUAL}} = V_{\text{REPORTED}} \times 10^{-1}$
Input current	(89h) READ_IIN	$\pm 5\%$ (10 - 133% of FL)	- 0.85 A to 5.9 A	100 μs	$I_{\text{ACTUAL}} = I_{\text{REPORTED}} \times 10^{-3}$
Output voltage ^[1]	(8Bh) READ_VOUT	$\pm 5\%$ (LL - HL)	4.25 V to 14 V	100 μs	$V_{\text{ACTUAL}} = V_{\text{REPORTED}} \times 10^{-1}$
Output current	(8Ch) READ_IOUT	$\pm 5\%$ (10 - 133% of FL)	- 27 A to 190 A	100 μs	$I_{\text{ACTUAL}} = I_{\text{REPORTED}} \times 10^{-2}$
Output resistance	(D4h) READ_ROUT	$\pm 5\%$ (50 - 100% of FL)	1.0 m Ω to 3.0 m Ω	100 ms	$R_{\text{ACTUAL}} = R_{\text{REPORTED}} \times 10^{-5}$
Temperature ^[2]	(8Dh) READ_TEMPERATURE_1	$\pm 7^{\circ}\text{C}$ (Full Range)	- 55 $^{\circ}\text{C}$ to 130 $^{\circ}\text{C}$	100 ms	$T_{\text{ACTUAL}} = T_{\text{REPORTED}}$

^[1] Default READ Output Voltage returned when unit is disabled = -300 V.

^[2] Default READ Temperature returned when unit is disabled = -273 $^{\circ}\text{C}$.

Variable Parameter					
<ul style="list-style-type: none"> • Factory setting of all below Thresholds and Warning limits are 100% of listed protection values. • Variables can be written only when module is disabled either EN pulled low or $V_{\text{IN}} < V_{\text{IN_UVLO}}$. • Module must remain in a disabled mode for 3 ms after any changes to the below variables allowing ample time to commit changes to EEPROM. 					
ATTRIBUTE	DIGITAL SUPERVISOR PMBus™ COMMAND ^[3]	CONDITIONS / NOTES	ACCURACY (RATED RANGE)	FUNCTIONAL REPORTING RANGE	DEFAULT VALUE
Input / Output Overvoltage Protection Limit	(55h) VIN_OV_FAULT_LIMIT	$V_{\text{IN_OVLO}}$ is automatically 3% lower than this set point	$\pm 5\%$ (LL - HL)	130 V to 435 V	100%
Input / Output Overvoltage Warning Limit	(57h) VIN_OV_WARN_LIMIT		$\pm 5\%$ (LL - HL)	130 V to 435 V	100%
Input / Output Undervoltage Protection Limit	(D7h) DISABLE_FAULTS	Can only be disabled to a preset default value	$\pm 5\%$ (LL - HL)	130 V or 260 V	100%
Input Overcurrent Protection Limit	(5Bh) IIN_OC_FAULT_LIMIT		$\pm 5\%$ (10 - 133% of FL)	0 to 5.25 A	100%
Input Overcurrent Warning Limit	(5Dh) IIN_OC_WARN_LIMIT		$\pm 5\%$ (10 - 133% of FL)	0 to 5.25 A	100%
Overtemperature Protection Limit	(4Fh) OT_FAULT_LIMIT		$\pm 7^{\circ}\text{C}$ (Full Range)	0 to 125 $^{\circ}\text{C}$	100%
Overtemperature Warning Limit	(51h) OT_WARN_LIMIT		$\pm 7^{\circ}\text{C}$ (Full Range)	0 to 125 $^{\circ}\text{C}$	100%
Turn on Delay	(60h) TON_DELAY	Additional time delay to the Undervoltage Startup Delay	$\pm 50 \mu\text{s}$	0 to 100 ms	0 ms

^[3] Refer to Digital Supervisor datasheet for complete list of supported commands.

Signal Characteristics

Specifications apply over all line, load conditions, unless otherwise noted; **Boldface** specifications apply over the temperature range of $-40^{\circ}\text{C} \leq T_{\text{INTERNAL}} \leq 125^{\circ}\text{C}$ (T-Grade); All other specifications are at $T_{\text{INTERNAL}} = 25^{\circ}\text{C}$ unless otherwise noted.

UART SER-IN / SER-OUT Pins									
<ul style="list-style-type: none"> • Universal Asynchronous Receiver/Transmitter (UART) pins. • The BCM communication version is not intended to be used without a Digital Supervisor. • Isolated I²C communication and telemetry is available when using Vicor Digital Isolator and Vicor Digital Supervisor. Please see specific product data sheet for more details. • UART SER-IN pin is internally pulled high using a 1.5 kΩ to 3.3 V. 									
SIGNAL TYPE	STATE	ATTRIBUTE	SYMBOL	CONDITIONS / NOTES	MIN	TYP	MAX	UNIT	
GENERAL I/O	Regular Operation	Baud Rate	BR _{UART}	Rate		750		Kbit/s	
		SER-IN Pin							
DIGITAL INPUT	Regular Operation	SER-IN Input Voltage Range	V _{SER-IN_IH}		2.3			V	
			V _{SER-IN_IL}				1	V	
		SER-IN rise time	t _{SER-IN_RISE}	10% to 90%		400		ns	
		SER-IN fall time	t _{SER-IN_FALL}	10% to 90%		25		ns	
		SER-IN R _{PULLUP}	R _{SER-IN_PLP}	Pull up to 3.3 V		1.5		k Ω	
		SER-IN External Capacitance	C _{SER-IN_EXT}				400	pF	
DIGITAL OUTPUT	Regular Operation	SER-OUT Pin							
		SER-OUT Output Voltage Range	V _{SER-OUT_OH}	0 mA \geq I _{OH} \geq -4 mA	2.8			V	
			V _{SER-OUT_OL}	0 mA \leq I _{OL} \leq 4 mA			0.5	V	
		SER-OUT rise time	t _{SER-OUT_RISE}	10% to 90%		55		ns	
		SER-OUT fall time	t _{SER-OUT_FALL}	10% to 90%		45		ns	
		SER-OUT source current	I _{SER-OUT}	V _{SER-OUT} = 2.8 V			6	mA	
		SER-OUT output impedance	Z _{SER-OUT}			120		Ω	

Enable / Disable Control								
<ul style="list-style-type: none"> • The EN pin is a standard analog I/O configured as an input to an internal μC. • It is internally pulled high to 3.3 V. • When held low the BCM internal bias will be disabled and the powertrain will be inactive. • In an array of BCMs, EN pins should be interconnected to synchronize startup and permit startup into full load conditions. • Enable / disable command will have no effect if the EN pin is disabled. 								
SIGNAL TYPE	STATE	ATTRIBUTE	SYMBOL	CONDITIONS / NOTES	MIN	TYP	MAX	UNIT
ANALOG INPUT	Startup	EN to Powertrain active time	t _{EN_START}	V _{IN} > V _{IN_UVLO+} , EN held low both conditions satisfied for t > t _{UVLO+_DELAY}		250		μs
	Regular Operation	EN Voltage Threshold	V _{ENABLE}		2.3		V	
		EN Resistance (Internal)	R _{EN_INT}	Internal pull up resistor		1.5		k Ω
		EN Disable Threshold	V _{EN_DISABLE_TH}				1	V

BCM Module Timing diagram

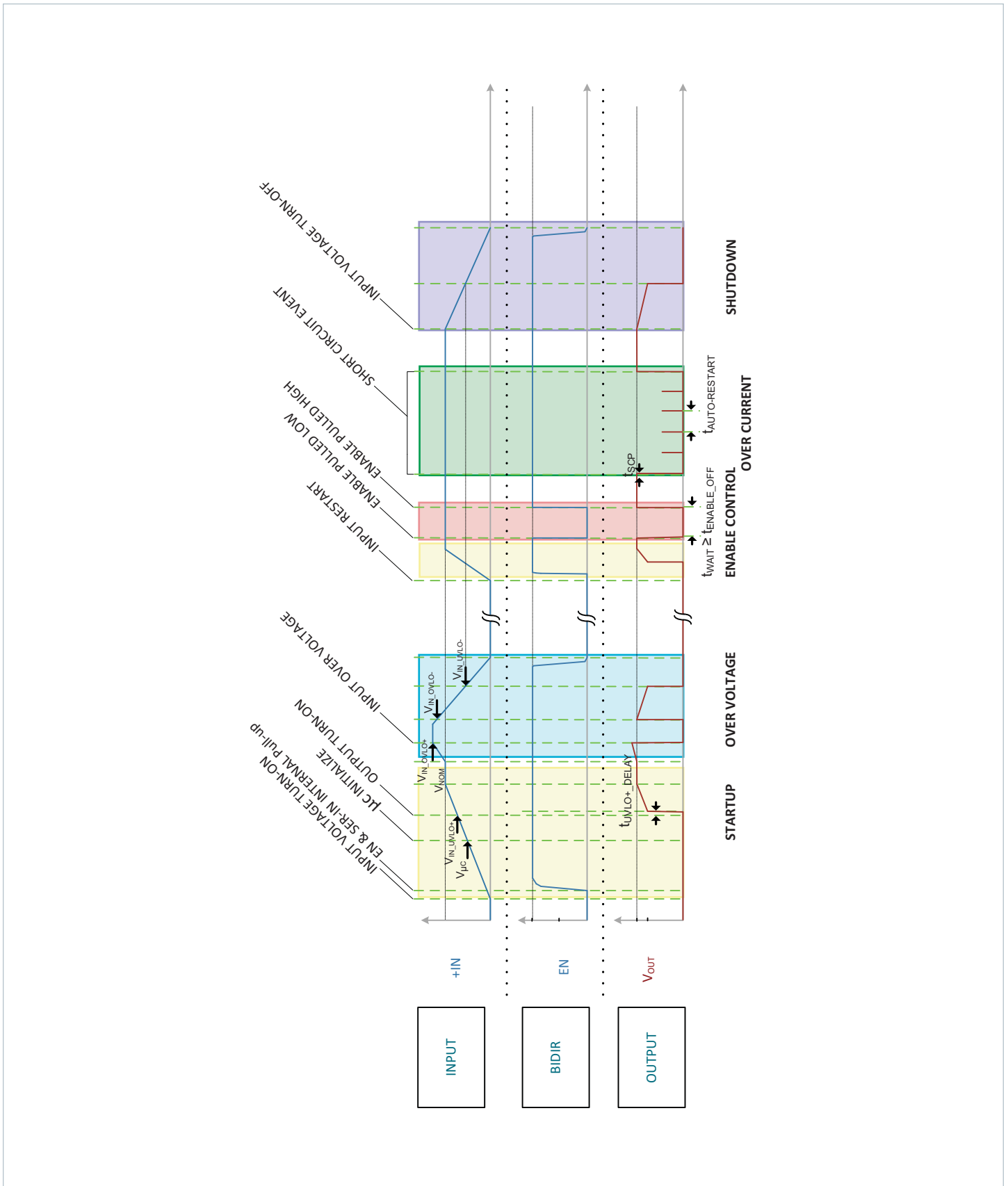

High Level Functional State Diagram

Conditions that cause state transitions are shown along arrows. Sub-sequence activities listed inside the state bubbles.

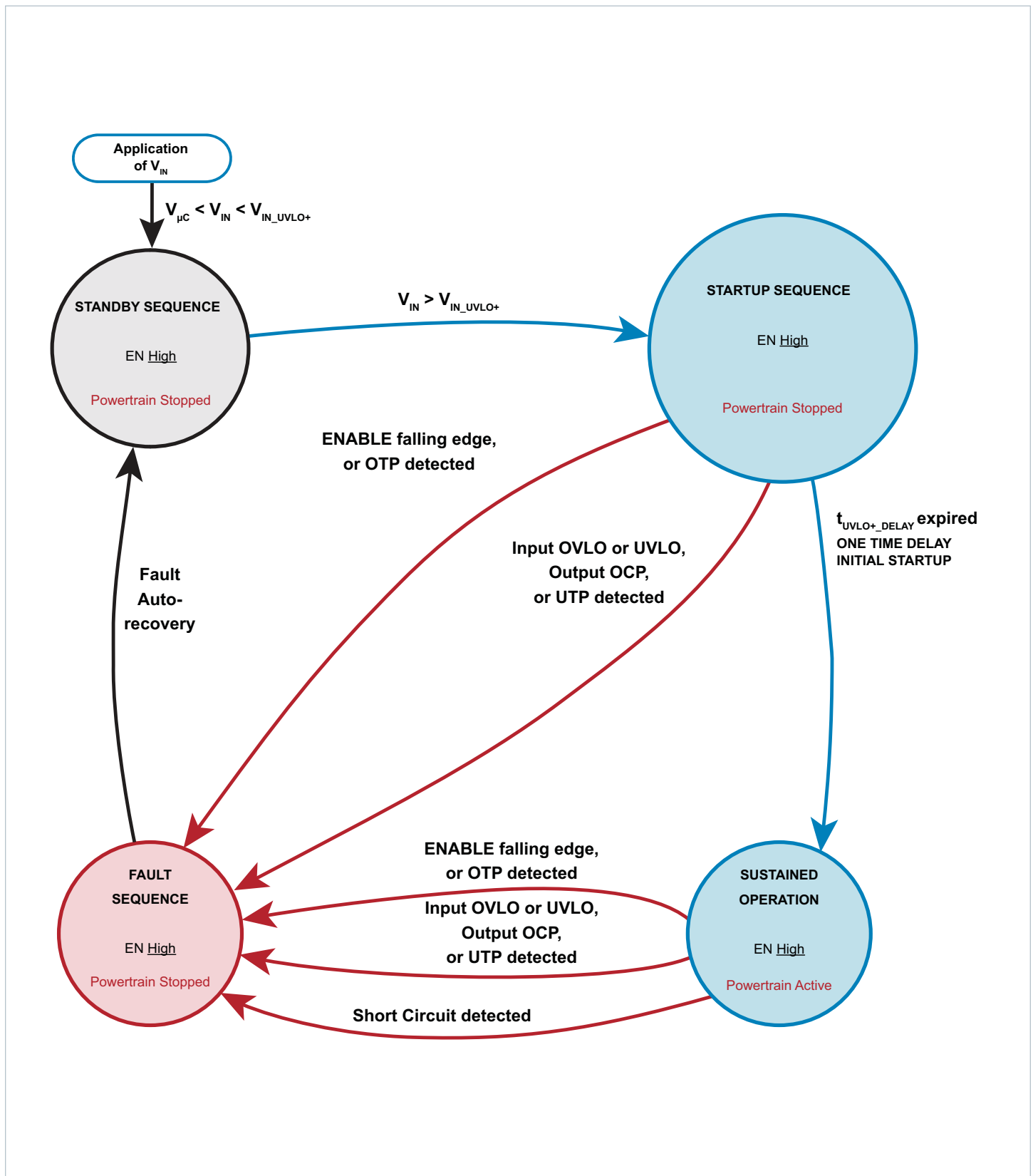

Application Characteristics

Product is mounted and temperature controlled via top side cold plate, unless otherwise noted. See associated figures for general trend data.

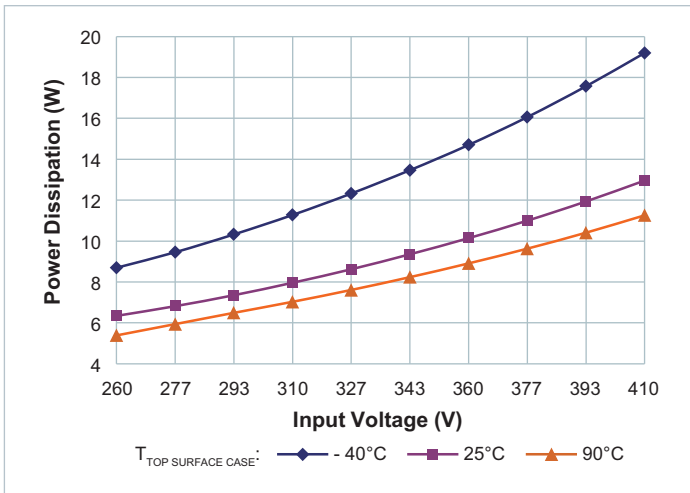

Figure 4 — No load power dissipation vs. V_{IN}

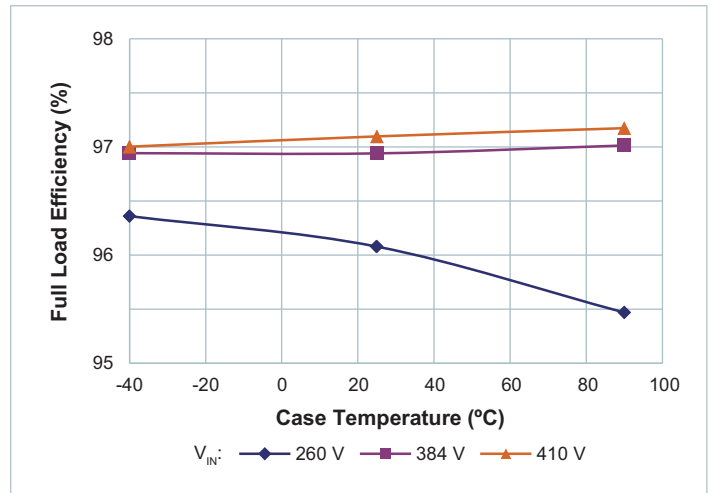

Figure 5 — Full load efficiency vs. temperature; V_{IN}

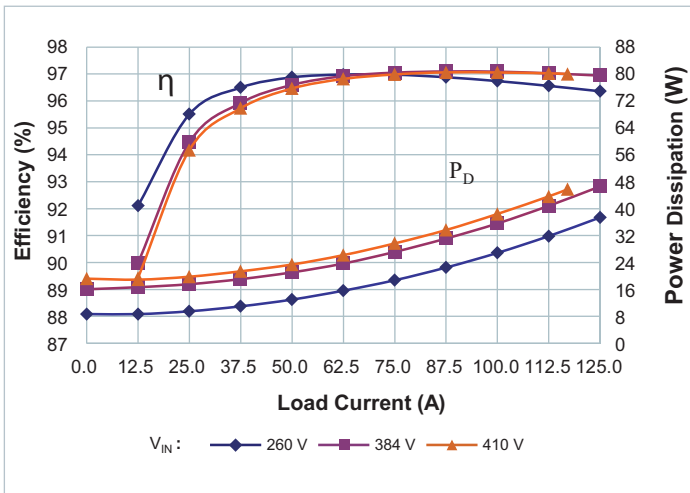

Figure 6 — Efficiency and power dissipation at $T_{CASE} = -40^{\circ}C$

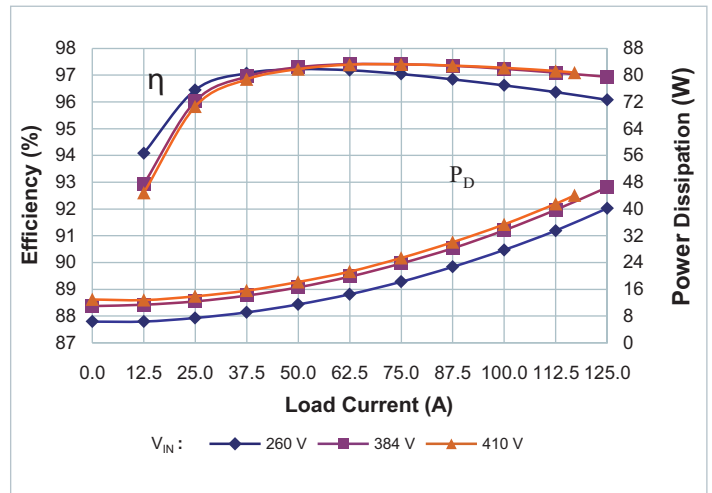

Figure 7 — Efficiency and power dissipation at $T_{CASE} = 25^{\circ}C$

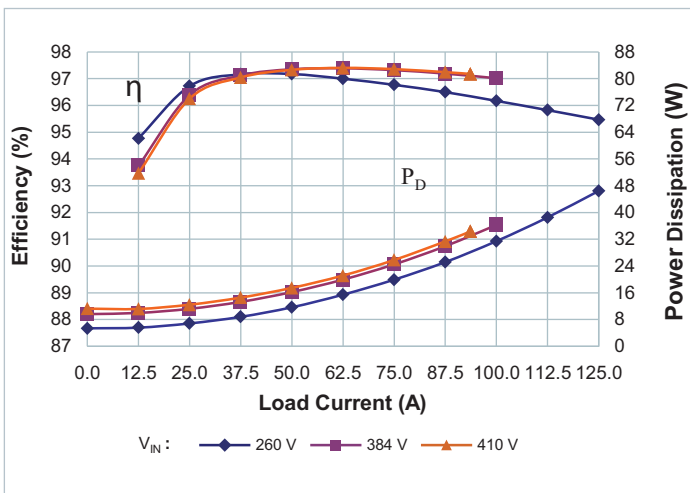

Figure 8 — Efficiency and power dissipation at $T_{CASE} = 90^{\circ}C$

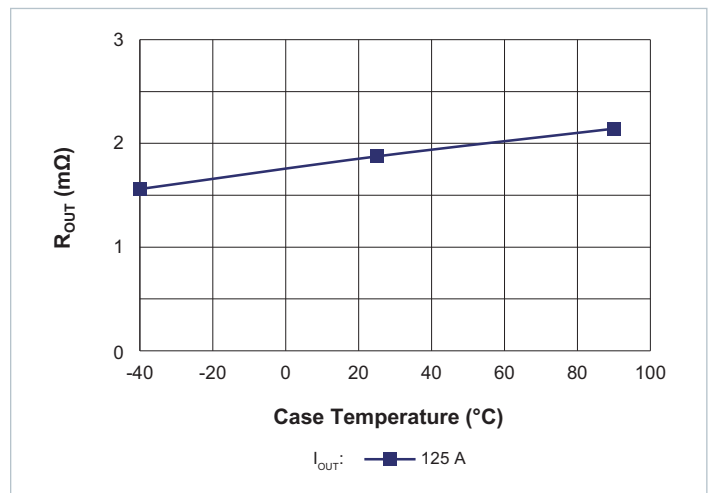

Figure 9 — R_{OUT} vs. temperature; Nominal V_{IN}

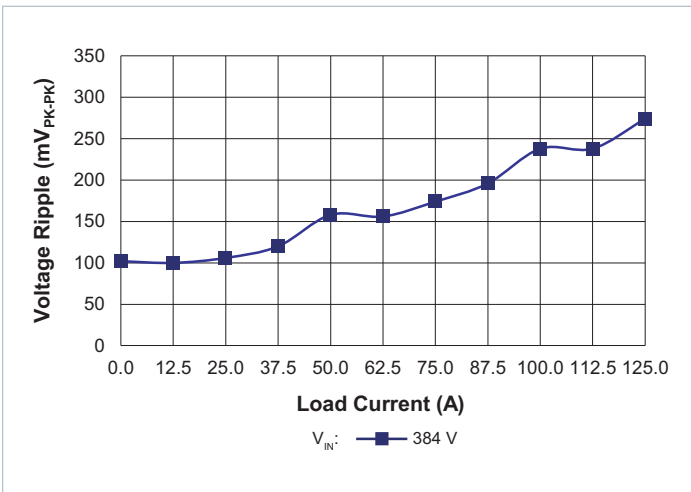

Figure 10 — V_{RIPPLE} VS. I_{OUT} ; No external C_{OUT} . Board mounted module, scope setting : 20 MHz analog BW

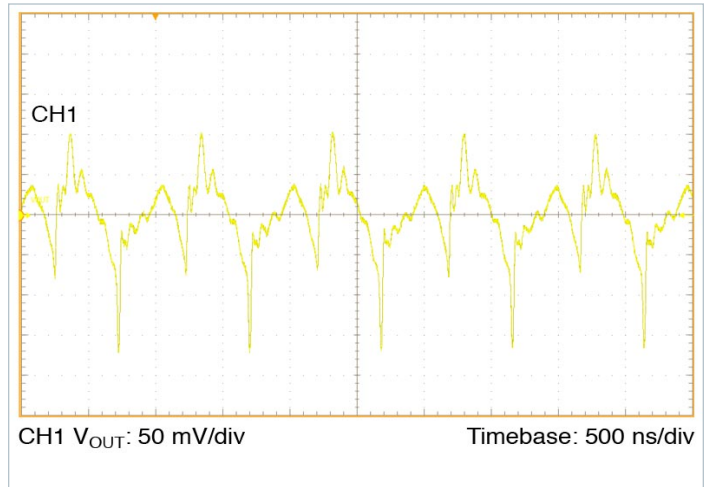

Figure 11 — Full load ripple, 10 μ F C_{IN} ; No external C_{OUT} . Board mounted module, scope setting : 20 MHz analog BW

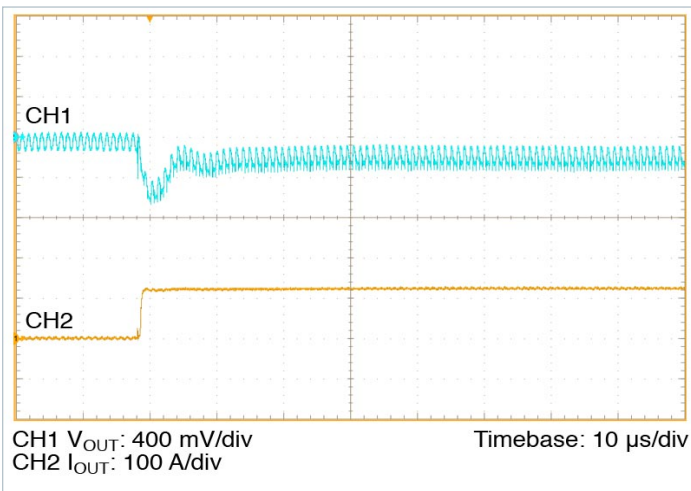

Figure 12 — 0 A– 125 A transient response: $C_{IN} = 10 \mu$ F, no external C_{OUT}

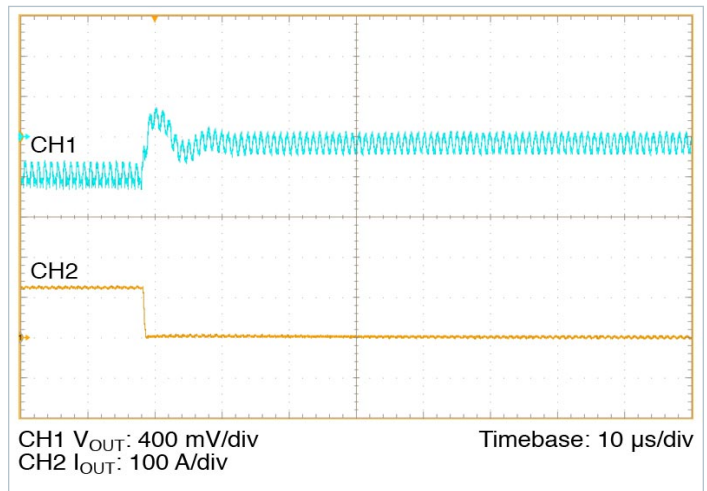

Figure 13 — 125 A – 0 A transient response: $C_{IN} = 10 \mu$ F, no external C_{OUT}

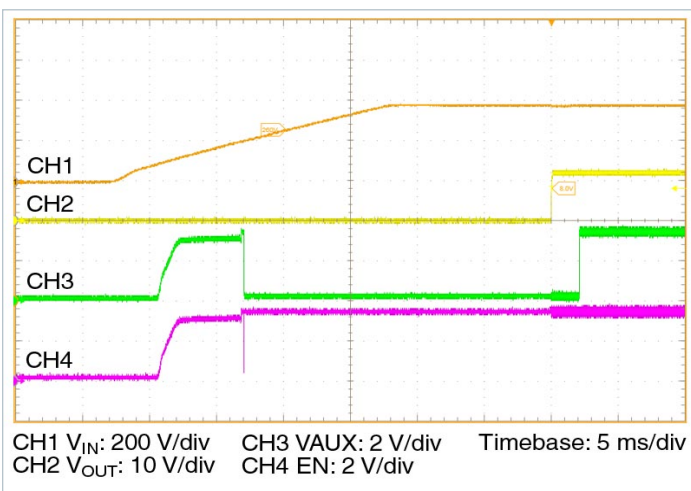

Figure 14 — Start up from application of $V_{IN} = 384$ V, 50% I_{OUT} , 100% C_{OUT}

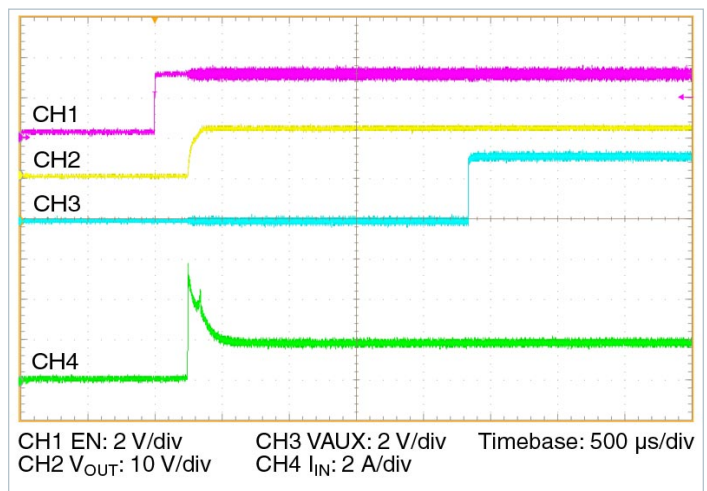

Figure 15 — Start up from application of EN with pre-applied $V_{IN} = 384$ V, 50% I_{OUT} , 100% C_{OUT}

General Characteristics

Specifications apply over all line, load conditions, unless otherwise noted; **Boldface** specifications apply over the temperature range of $-40^{\circ}\text{C} \leq T_{\text{INTERNAL}} \leq 125^{\circ}\text{C}$ (T-Grade); All other specifications are at $T_{\text{INTERNAL}} = 25^{\circ}\text{C}$ unless otherwise noted.

Attribute	Symbol	Conditions / Notes	Min	Typ	Max	Unit
Mechanical						
Length	L		60.87 / [2.396]	61.00 / [2.402]	61.13 / [2.407]	mm / [in]
Width	W		24.76 / [0.975]	25.14 / [0.990]	25.52 / [1.005]	mm / [in]
Height	H		7.21 / [0.284]	7.26 / [0.286]	7.31 / [0.288]	mm / [in]
Volume	Vol	Without heatsink		11.13 / [0.679]		cm ³ / [in ³]
Weight	W			41 / [1.45]		g / [oz]
Lead finish		Nickel	0.51		2.03	μm
		Palladium	0.02		0.15	
		Gold	0.003		0.051	
Thermal						
Operating temperature	T _{INTERNAL}	BCM384P120T1K5AC1 (T-Grade)	-40		125	°C
		BCM384P120M1K5AC1 (M-Grade)	-55		125	°C
Thermal resistance top side	Φ _{INT-TOP}	Estimated thermal resistance to maximum temperature internal component from isothermal top		1.14		°C/W
Thermal resistance leads	Φ _{INT-LEADS}	Estimated thermal resistance to maximum temperature internal component from isothermal leads		1.35		°C/W
Thermal resistance bottom side	Φ _{INT-BOTTOM}	Estimated thermal resistance to maximum temperature internal component from isothermal bottom		1.07		°C/W
Thermal capacity				34		Ws / °C
Assembly						
Storage Temperature	T _{ST}	BCM384P120T1K5AC1 (T-Grade)	-55		125	°C
		BCM384P120M1K5AC1 (M-Grade)	-65		125	°C
ESD Withstand	ESD _{HBM}	Human Body Model, "ESDA / JEDEC JDS-001-2012" Class I-C (1kV to < 2 kV)				
	ESD _{CDM}	Charge Device Model, "JESD 22-C101-E" Class II (200V to < 500V)				

General Characteristics (Cont.)

Specifications apply over all line, load conditions, unless otherwise noted; **Boldface** specifications apply over the temperature range of $-40^{\circ}\text{C} \leq T_{\text{INTERNAL}} \leq 125^{\circ}\text{C}$ (T-Grade); All other specifications are at $T_{\text{INTERNAL}} = 25^{\circ}\text{C}$ unless otherwise noted.

Attribute	Symbol	Conditions / Notes	Min	Typ	Max	Unit
Soldering ^[1]						
Peak temperature Top case					135	°C
Safety						
Isolation voltage	V _{HIPO} T	IN to OUT	4,242			Vdc
		IN to CASE	2,121			
		OUT to CASE	2,121			
Isolation capacitance	C _{IN_OUT}	Unpowered unit	620	780	940	pF
Isolation resistance	R _{IN_OUT}	At 500 Vdc	10			MΩ
MTBF		MIL-HDBK-217Plus Parts Count - 25°C Ground Benign, Stationary, Indoors / Computer		2.31		MHrs
		Telcordia Issue 2 - Method I Case III; 25°C Ground Benign, Controlled		3.41		MHrs
Agency approvals / standards		cTUVus "EN 60950-1 " cURus "UL 60950-1 " CE Marked for Low Voltage Directive and RoHS Recast Directive, as applicable				

^[1] Product is not intended for reflow solder attach.

BCM Module Block Diagram

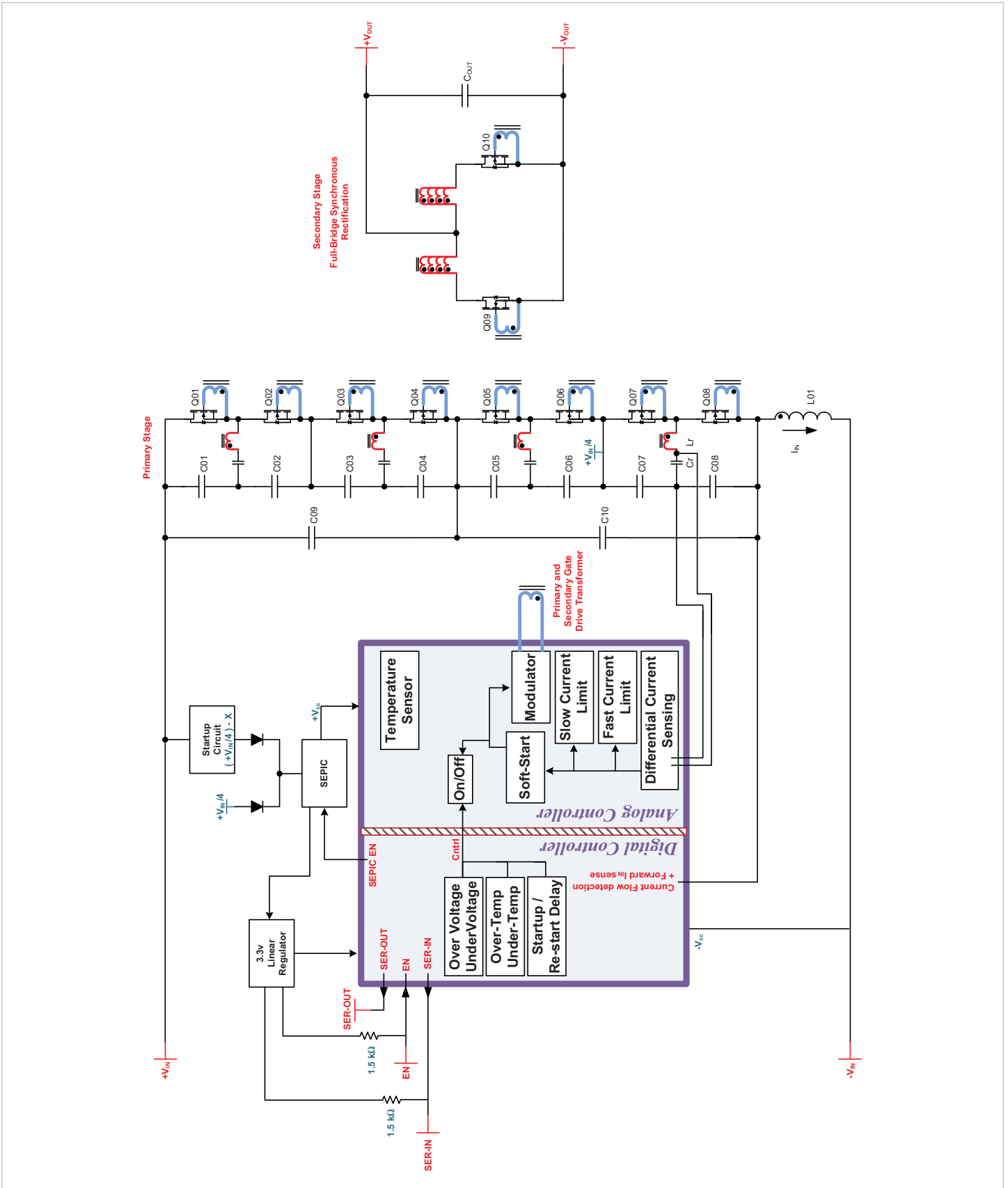

System Diagram

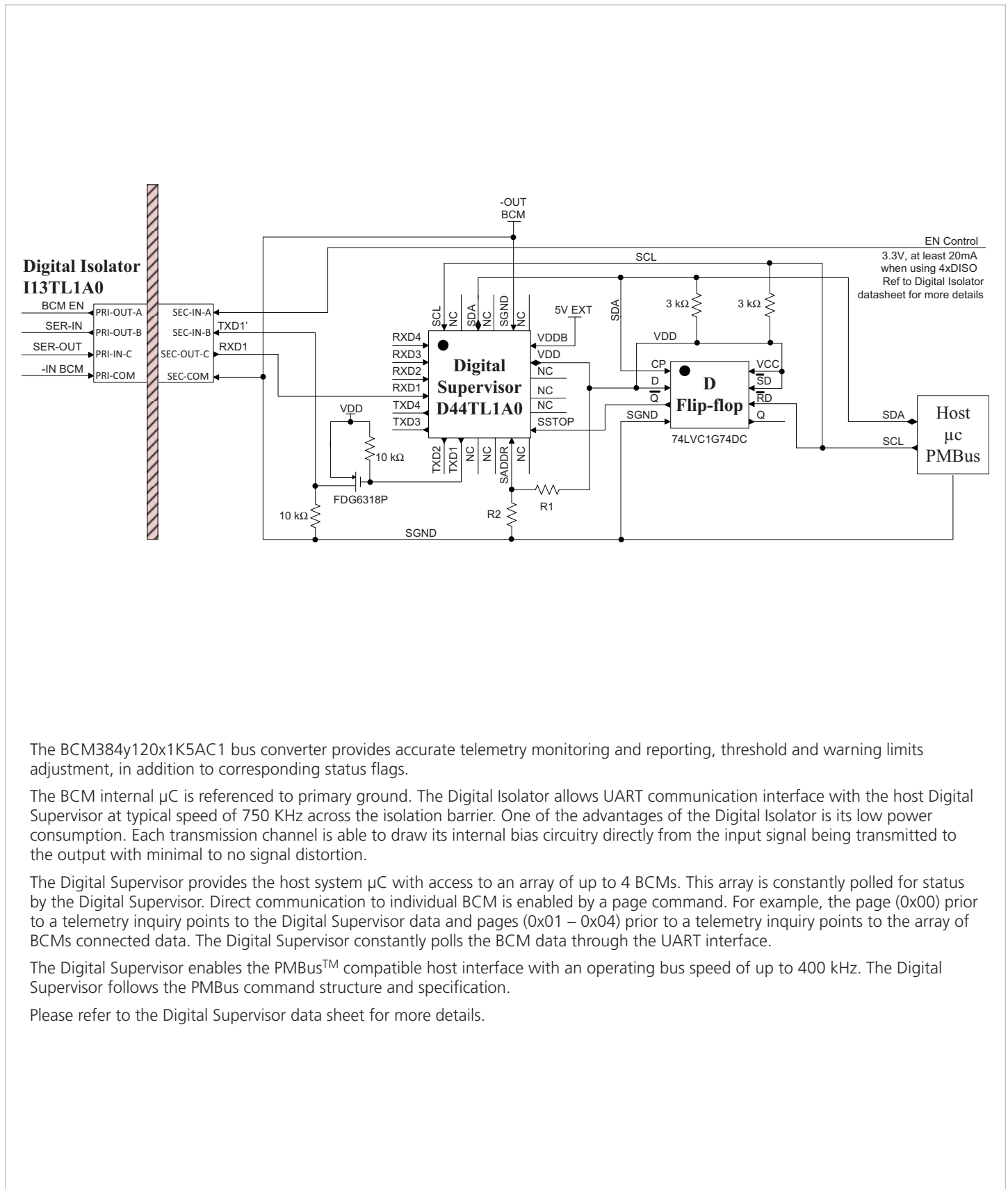

The BCM384y120x1K5AC1 bus converter provides accurate telemetry monitoring and reporting, threshold and warning limits adjustment, in addition to corresponding status flags.

The BCM internal μC is referenced to primary ground. The Digital Isolator allows UART communication interface with the host Digital Supervisor at typical speed of 750 KHz across the isolation barrier. One of the advantages of the Digital Isolator is its low power consumption. Each transmission channel is able to draw its internal bias circuitry directly from the input signal being transmitted to the output with minimal to no signal distortion.

The Digital Supervisor provides the host system μC with access to an array of up to 4 BCMS. This array is constantly polled for status by the Digital Supervisor. Direct communication to individual BCM is enabled by a page command. For example, the page (0x00) prior to a telemetry inquiry points to the Digital Supervisor data and pages (0x01 – 0x04) prior to a telemetry inquiry points to the array of BCMS connected data. The Digital Supervisor constantly polls the BCM data through the UART interface.

The Digital Supervisor enables the PMBus™ compatible host interface with an operating bus speed of up to 400 kHz. The Digital Supervisor follows the PMBus command structure and specification.

Please refer to the Digital Supervisor data sheet for more details.

Sine Amplitude Converter™ Point of Load Conversion

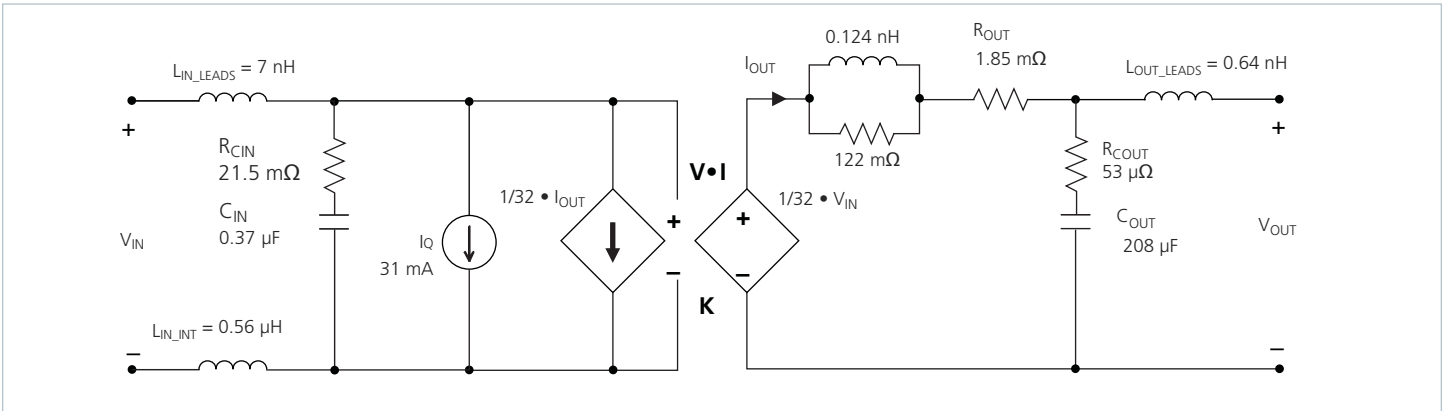

Figure 16 — BCM module AC model

The Sine Amplitude Converter (SAC™) uses a high frequency resonant tank to move energy from input to output. (The resonant tank is formed by Cr and leakage inductance Lr in the power transformer windings as shown in the BCM module Block Diagram). The resonant LC tank, operated at high frequency, is amplitude modulated as a function of input voltage and output current. A small amount of capacitance embedded in the input and output stages of the module is sufficient for full functionality and is key to achieving high power density.

The BCM384y120x1K5AC1 SAC can be simplified into the preceding model.

At no load:

$$V_{OUT} = V_{IN} \cdot K \tag{1}$$

K represents the “turns ratio” of the SAC.

Rearranging Eq (1):

$$K = \frac{V_{OUT}}{V_{IN}} \tag{2}$$

In the presence of load, V_OUT is represented by:

$$V_{OUT} = V_{IN} \cdot K - I_{OUT} \cdot R_{OUT} \tag{3}$$

and I_OUT is represented by:

$$I_{OUT} = \frac{I_{IN} - I_Q}{K} \tag{4}$$

R_OUT represents the impedance of the SAC, and is a function of the R_DS(on) of the input and output MOSFETs and the winding resistance of the power transformer. I_Q represents the quiescent current of the SAC control, gate drive circuitry, and core losses.

The use of DC voltage transformation provides additional interesting attributes. Assuming that R_OUT = 0 Ω and I_Q = 0 A, Eq. (3) now becomes Eq. (1) and is essentially load independent, resistor R is now placed in series with V_IN.

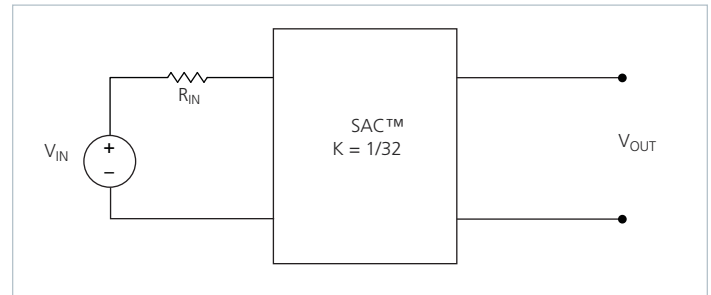

Figure 17 — K = 1/32 Sine Amplitude Converter with series input resistor

The relationship between V_IN and V_OUT becomes:

$$V_{OUT} = (V_{IN} - I_{IN} \cdot R_{IN}) \cdot K \tag{5}$$

Substituting the simplified version of Eq. (4) (I_Q is assumed = 0 A) into Eq. (5) yields:

$$V_{OUT} = V_{IN} \cdot K - I_{OUT} \cdot R_{IN} \cdot K^2 \tag{6}$$

This is similar in form to Eq. (3), where R_{OUT} is used to represent the characteristic impedance of the SAC™. However, in this case a real R on the input side of the SAC is effectively scaled by K^2 with respect to the output.

Assuming that $R = 1 \Omega$, the effective R as seen from the secondary side is $0.98 \text{ m}\Omega$, with $K = 1/32$.

A similar exercise should be performed with the addition of a capacitor or shunt impedance at the input to the SAC. A switch in series with V_{IN} is added to the circuit. This is depicted in Figure 18.

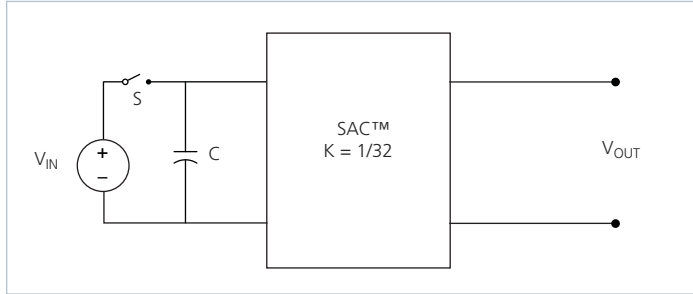

Figure 18 — Sine Amplitude Converter with input capacitor

A change in V_{IN} with the switch closed would result in a change in capacitor current according to the following equation:

$$I_C(t) = C \frac{dV_{IN}}{dt} \quad (7)$$

Assume that with the capacitor charged to V_{IN} , the switch is opened and the capacitor is discharged through the idealized SAC. In this case,

$$I_C = I_{OUT} \cdot K \quad (8)$$

substituting Eq. (1) and (8) into Eq. (7) reveals:

$$I_{OUT} = \frac{C}{K^2} \cdot \frac{dV_{OUT}}{dt} \quad (9)$$

The equation in terms of the output has yielded a K^2 scaling factor for C, specified in the denominator of the equation.

A K factor less than unity results in an effectively larger capacitance on the output when expressed in terms of the input. With a $K = 1/32$ as shown in Figure 18, $C = 1 \mu\text{F}$ would appear as $C = 1024 \mu\text{F}$ when viewed from the output.

Low impedance is a key requirement for powering a high-current, low-voltage load efficiently. A switching regulation stage should have minimal impedance while simultaneously providing appropriate filtering for any switched current. The use of a SAC between the regulation stage and the point of load provides a dual benefit of scaling down series impedance leading back to the source and scaling up shunt capacitance or energy storage as a function of its K factor squared. However, the benefits are not useful if the series impedance of the SAC is too high. The impedance of the SAC must be low, i.e. well beyond the crossover frequency of the system.

A solution for keeping the impedance of the SAC low involves switching at a high frequency. This enables small magnetic components because magnetizing currents remain low. Small magnetics mean small path lengths for turns. Use of low loss core material at high frequencies also reduces core losses.

The two main terms of power loss in the BCM module are:

- No load power dissipation (P_{NL}): defined as the power used to power up the module with an enabled powertrain at no load.
- Resistive loss (R_{OUT}): refers to the power loss across the BCM® module modeled as pure resistive impedance.

$$P_{DISSIPATED} = P_{NL} + P_{R_{OUT}} \quad (10)$$

Therefore,

$$P_{OUT} = P_{IN} - P_{DISSIPATED} = P_{IN} - P_{NL} - P_{R_{OUT}} \quad (11)$$

The above relations can be combined to calculate the overall module efficiency:

$$\eta = \frac{P_{OUT}}{P_{IN}} = \frac{P_{IN} - P_{NL} - P_{R_{OUT}}}{P_{IN}} \quad (12)$$

$$= \frac{V_{IN} \cdot I_{IN} - P_{NL} - (I_{OUT})^2 \cdot R_{OUT}}{V_{IN} \cdot I_{IN}}$$

$$= 1 - \left(\frac{P_{NL} + (I_{OUT})^2 \cdot R_{OUT}}{V_{IN} \cdot I_{IN}} \right)$$

Input and Output Filter Design

A major advantage of SAC™ systems versus conventional PWM converters is that the transformer based SAC does not require external filtering to function properly. The resonant LC tank, operated at extreme high frequency, is amplitude modulated as a function of input voltage and output current and efficiently transfers charge through the isolation transformer. A small amount of capacitance embedded in the input and output stages of the module is sufficient for full functionality and is key to achieving power density.

This paradigm shift requires system design to carefully evaluate external filters in order to:

- **Guarantee low source impedance:**
To take full advantage of the BCM module's dynamic response, the impedance presented to its input terminals must be low from DC to approximately 5 MHz. The connection of the bus converter module to its power source should be implemented with minimal distribution inductance. If the interconnect inductance exceeds 100 nH, the input should be bypassed with a RC damper to retain low source impedance and stable operation. With an interconnect inductance of 200 nH, the RC damper may be as high as 1 μF in series with 0.3 Ω. A single electrolytic or equivalent low-Q capacitor may be used in place of the series RC bypass.
- **Further reduce input and/or output voltage ripple without sacrificing dynamic response:**
Given the wide bandwidth of the module, the source response is generally the limiting factor in the overall system response. Anomalies in the response of the source will appear at the output of the module multiplied by its K factor.
- **Protect the module from overvoltage transients imposed by the system that would exceed maximum ratings and induce stresses:**
The module input/output voltage ranges shall not be exceeded. An internal overvoltage lockout function prevents operation outside of the normal operating input range. Even when disabled, the powertrain is exposed to the applied voltage and power MOSFETs must withstand it.

Total load capacitance at the output of the BCM module shall not exceed the specified maximum. Owing to the wide bandwidth and low output impedance of the module, low-frequency bypass capacitance and significant energy storage may be more densely and efficiently provided by adding capacitance at the input of the module. At frequencies <500 kHz the module appears as an impedance of R_{OUT} between the source and load.

Within this frequency range, capacitance at the input appears as effective capacitance on the output per the relationship defined in Eq. (13).

$$C_{OUT} = \frac{C_{IN}}{K^2} \quad (13)$$

This enables a reduction in the size and number of capacitors used in a typical system.

Thermal Considerations

The ChiP package provides a high degree of flexibility in that it presents three pathways to remove heat from internal power dissipating components. Heat may be removed from the top surface, the bottom surface and the leads. The extent to which these three surfaces are cooled is a key component for determining the maximum power that is available from a ChiP, as can be seen from Figure 1.

Since the ChiP has a maximum internal temperature rating, it is necessary to estimate this internal temperature based on a real thermal solution. Given that there are three pathways to remove heat from the ChiP, it is helpful to simplify the thermal solution into a roughly equivalent circuit where power dissipation is modeled as a current source, isothermal surface temperatures are represented as voltage sources and the thermal resistances are represented as resistors. Figure 19 shows the "thermal circuit" for a VI Chip® BCM module 2361 in an application where the top, bottom, and leads are cooled. In this case, the BCM power dissipation is PD_{TOTAL} and the three surface temperatures are represented as T_{CASE_TOP}, T_{CASE_BOTTOM}, and T_{LEADS}. This thermal system can now be very easily analyzed using a SPICE simulator with simple resistors, voltage sources, and a current source. The results of the simulation would provide an estimate of heat flow through the various pathways as well as internal temperature.

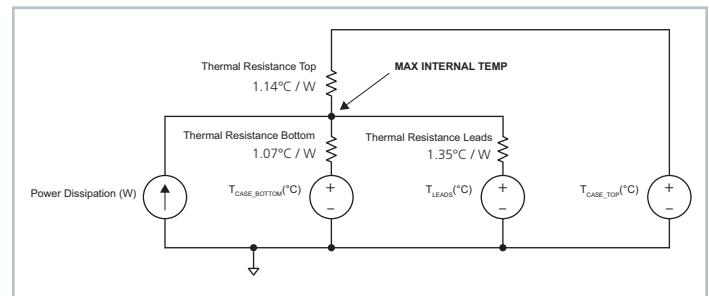

Figure 19 — Double side cooling and leads thermal model

Alternatively, equations can be written around this circuit and analyzed algebraically:

$$T_{INT} - PD_1 \cdot 1.24 = T_{CASE_TOP}$$

$$T_{INT} - PD_2 \cdot 1.24 = T_{CASE_BOTTOM}$$

$$T_{INT} - PD_3 \cdot 7 = T_{LEADS}$$

$$PD_{TOTAL} = PD_1 + PD_2 + PD_3$$

Where T_{INT} represents the internal temperature and PD₁, PD₂, and PD₃ represent the heat flow through the top side, bottom side, and leads respectively.

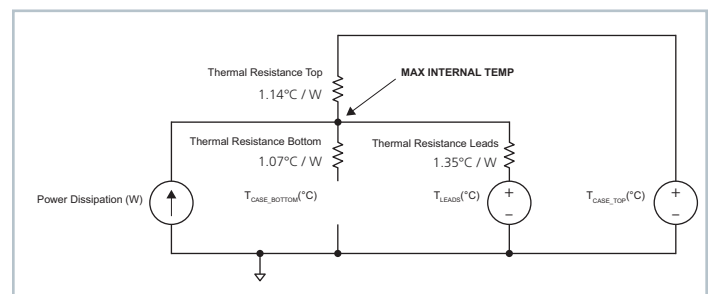

Figure 20 — One side cooling and leads thermal model

Figure 20 shows a scenario where there is no bottom side cooling. In this case, the heat flow path to the bottom is left open and the equations now simplify to:

$$T_{INT} - PD_1 \cdot 1.24 = T_{CASE_TOP}$$

$$T_{INT} - PD_3 \cdot 7 = T_{LEADS}$$

$$PD_{TOTAL} = PD_1 + PD_3$$

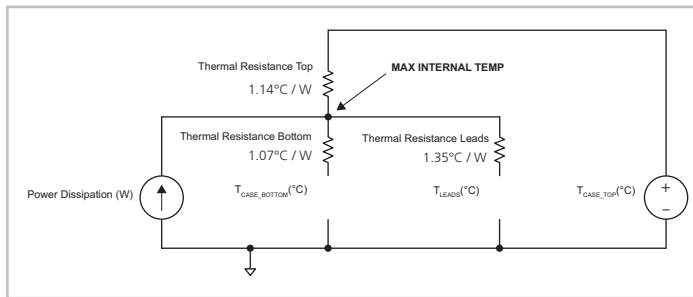

Figure 21 — One side cooling thermal model

Figure 21 shows a scenario where there is no bottom side and leads cooling. In this case, the heat flow path to the bottom is left open and the equations now simplify to:

$$T_{INT} - PD_1 \cdot 1.24 = T_{CASE_TOP}$$

$$PD_{TOTAL} = PD_1$$

Please note that Vicor has a suite of online tools, including a simulator and thermal estimator which greatly simplify the task of determining whether or not a BCM thermal configuration is valid for a given condition. These tools can be found at:

<http://www.vicorpower.com/powerbench>.

Current Sharing

The performance of the SAC™ topology is based on efficient transfer of energy through a transformer without the need of closed loop control. For this reason, the transfer characteristic can be approximated by an ideal transformer with a positive temperature coefficient series resistance.

This type of characteristic is close to the impedance characteristic of a DC power distribution system both in dynamic (AC) behavior and for steady state (DC) operation.

When multiple BCM modules of a given part number are connected in an array they will inherently share the load current according to the equivalent impedance divider that the system implements from the power source to the point of load.

Some general recommendations to achieve matched array impedances include:

- Dedicate common copper planes within the PCB to deliver and return the current to the modules.
- Provide as symmetric a PCB layout as possible among modules
- An input filter is required for an array of BCMs in order to prevent circulating currents.

For further details see [AN:016 Using BCM Bus Converters in High Power Arrays](#).

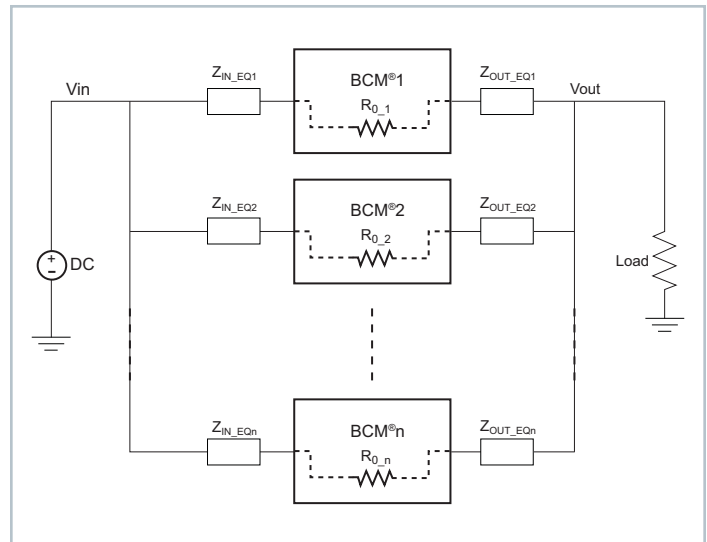

Figure 22 — BCM module array

Fuse Selection

In order to provide flexibility in configuring power systems VI Chip® modules are not internally fused. Input line fusing of VI Chip products is recommended at system level to provide thermal protection in case of catastrophic failure.

The fuse shall be selected by closely matching system requirements with the following characteristics:

- Current rating
(usually greater than maximum current of BCM module)
- Maximum voltage rating
(usually greater than the maximum possible input voltage)
- Ambient temperature
- Nominal melting I^2t
- Recommend fuse: ≤ 5 A Bussmann PC-Tron

Reverse Operation

BCM modules are capable of reverse power operation. Once the unit is started, energy will be transferred from secondary back to the primary whenever the secondary voltage exceeds $V_{IN} \cdot K$. The module will continue operation in this fashion for as long as no faults occur.

The BCM384y120x1K5AC1 has not been qualified for continuous operation in a reverse power condition. Furthermore fault protections which help protect the module in forward operation will not fully protect the module in reverse operation.

Transient operation in reverse is expected in cases where there is significant energy storage on the output and transient voltages appear on the input. Transient reverse power operation of less than 10 ms, 10% duty cycle is permitted and has been qualified to cover these cases.

BCM Module Through Hole Package Mechanical Drawing and Recommended Land Pattern

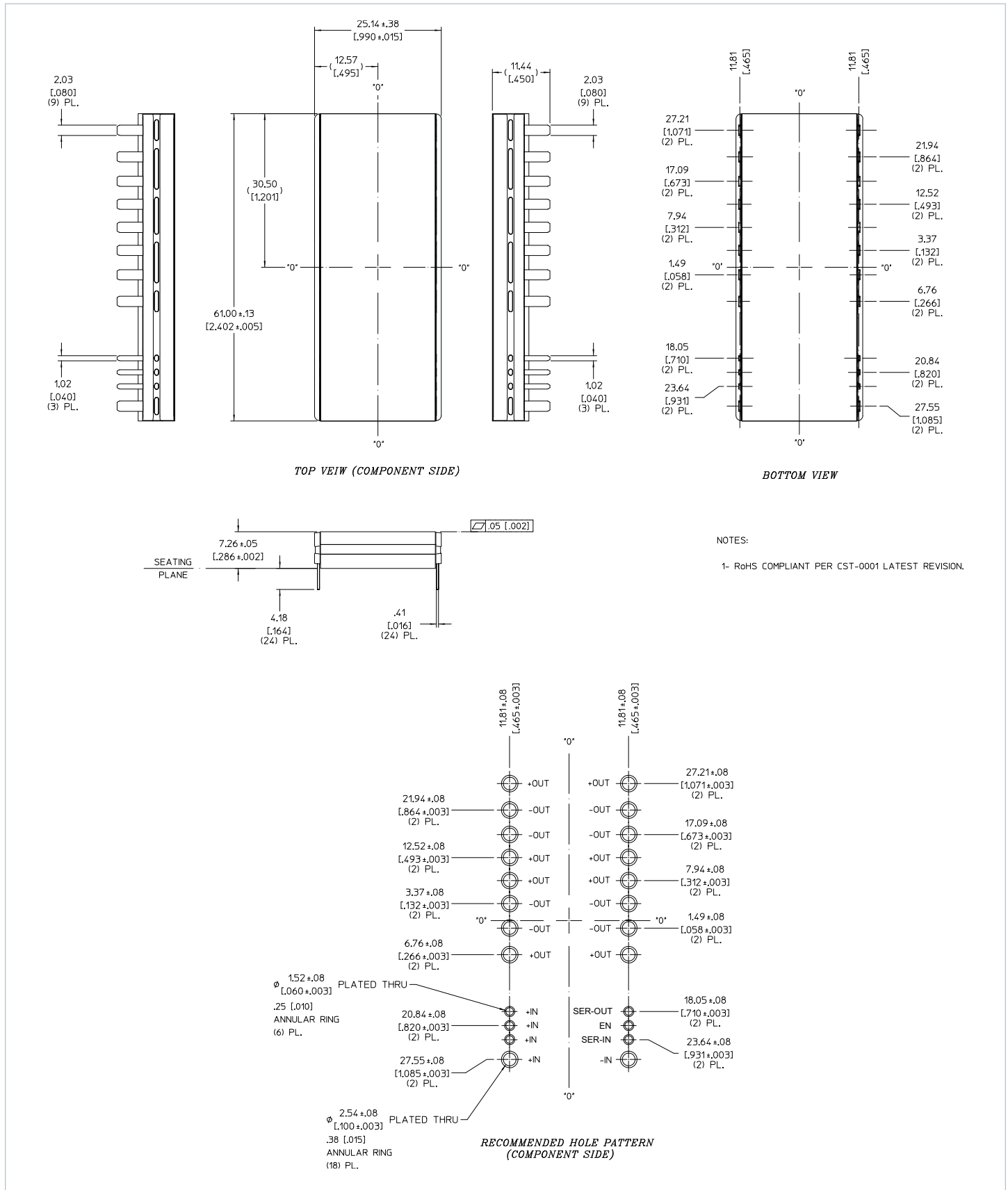

Vicor's comprehensive line of power solutions includes high density AC-DC and DC-DC modules and accessory components, fully configurable AC-DC and DC-DC power supplies, and complete custom power systems.

Information furnished by Vicor is believed to be accurate and reliable. However, no responsibility is assumed by Vicor for its use. Vicor makes no representations or warranties with respect to the accuracy or completeness of the contents of this publication. Vicor reserves the right to make changes to any products, specifications, and product descriptions at any time without notice. Information published by Vicor has been checked and is believed to be accurate at the time it was printed; however, Vicor assumes no responsibility for inaccuracies. Testing and other quality controls are used to the extent Vicor deems necessary to support Vicor's product warranty. Except where mandated by government requirements, testing of all parameters of each product is not necessarily performed.

Specifications are subject to change without notice.

Vicor's Standard Terms and Conditions

All sales are subject to Vicor's Standard Terms and Conditions of Sale, which are available on Vicor's webpage or upon request.

Product Warranty

In Vicor's standard terms and conditions of sale, Vicor warrants that its products are free from non-conformity to its Standard Specifications (the "Express Limited Warranty"). This warranty is extended only to the original Buyer for the period expiring two (2) years after the date of shipment and is not transferable.

UNLESS OTHERWISE EXPRESSLY STATED IN A WRITTEN SALES AGREEMENT SIGNED BY A DULY AUTHORIZED VICOR SIGNATORY, VICOR DISCLAIMS ALL REPRESENTATIONS, LIABILITIES, AND WARRANTIES OF ANY KIND (WHETHER ARISING BY IMPLICATION OR BY OPERATION OF LAW) WITH RESPECT TO THE PRODUCTS, INCLUDING, WITHOUT LIMITATION, ANY WARRANTIES OR REPRESENTATIONS AS TO MERCHANTABILITY, FITNESS FOR PARTICULAR PURPOSE, INFRINGEMENT OF ANY PATENT, COPYRIGHT, OR OTHER INTELLECTUAL PROPERTY RIGHT, OR ANY OTHER MATTER.

This warranty does not extend to products subjected to misuse, accident, or improper application, maintenance, or storage. Vicor shall not be liable for collateral or consequential damage. Vicor disclaims any and all liability arising out of the application or use of any product or circuit and assumes no liability for applications assistance or buyer product design. Buyers are responsible for their products and applications using Vicor products and components. Prior to using or distributing any products that include Vicor components, buyers should provide adequate design, testing and operating safeguards.

Vicor will repair or replace defective products in accordance with its own best judgment. For service under this warranty, the buyer must contact Vicor to obtain a Return Material Authorization (RMA) number and shipping instructions. Products returned without prior authorization will be returned to the buyer. The buyer will pay all charges incurred in returning the product to the factory. Vicor will pay all reshipment charges if the product was defective within the terms of this warranty.

Life Support Policy

VICOR'S PRODUCTS ARE NOT AUTHORIZED FOR USE AS CRITICAL COMPONENTS IN LIFE SUPPORT DEVICES OR SYSTEMS WITHOUT THE EXPRESS PRIOR WRITTEN APPROVAL OF THE CHIEF EXECUTIVE OFFICER AND GENERAL COUNSEL OF VICOR CORPORATION. As used herein, life support devices or systems are devices which (a) are intended for surgical implant into the body, or (b) support or sustain life and whose failure to perform when properly used in accordance with instructions for use provided in the labeling can be reasonably expected to result in a significant injury to the user. A critical component is any component in a life support device or system whose failure to perform can be reasonably expected to cause the failure of the life support device or system or to affect its safety or effectiveness. Per Vicor Terms and Conditions of Sale, the user of Vicor products and components in life support applications assumes all risks of such use and indemnifies Vicor against all liability and damages.

Intellectual Property Notice

Vicor and its subsidiaries own Intellectual Property (including issued U.S. and Foreign Patents and pending patent applications) relating to the products described in this data sheet. No license, whether express, implied, or arising by estoppel or otherwise, to any intellectual property rights is granted by this document. Interested parties should contact Vicor's Intellectual Property Department.

The products described on this data sheet are protected by the following U.S. Patents Numbers:

5,945,130; 6,403,009; 6,710,257; 6,911,848; 6,930,893; 6,934,166; 6,940,013; 6,969,909; 7,038,917; 7,145,186; 7,166,898; 7,187,263; 7,202,646; 7,361,844; D496,906; D505,114; D506,438; D509,472; and for use under 6,975,098 and 6,984,965.

Vicor Corporation

25 Frontage Road
Andover, MA, USA 01810
Tel: 800-735-6200
Fax: 978-475-6715

email

Customer Service: custserv@vicorpower.com

Technical Support: apps@vicorpower.com