

MG17225WB-BN4MM

RoHS

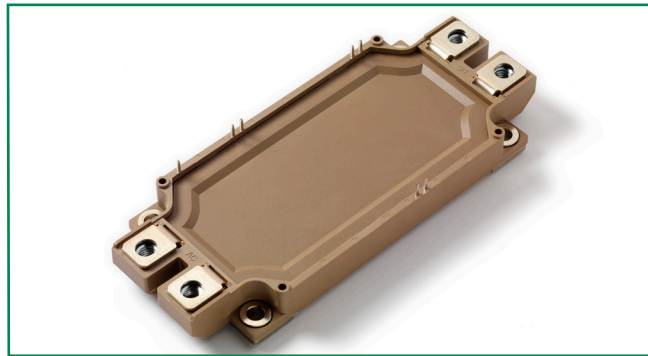

Features

- IGBT³ CHIP(1700V Trench+Field Stop technology)
- Low turn-off losses, short tail current
- $V_{CE(sat)}$ with positive temperature coefficient
- DIODE CHIP(1700V EMCON 3 technology)
- Free wheeling diodes with fast and soft reverse recovery

Applications

- AC motor control
- Motion/servo control
- Photovoltaic/Fuel cell
- Inverter and power supplies

Module Characteristics ($T_J = 25^\circ\text{C}$, unless otherwise specified)

Symbol	Parameters	Test Conditions	Min	Typ	Max	Unit
$T_{J\max}$	Max. Junction Temperature				150	$^\circ\text{C}$
T_{Jop}	Operating Temperature		-40		125	$^\circ\text{C}$
T_{stg}	Storage Temperature		-40		125	$^\circ\text{C}$
V_{isol}	Insulation Test Voltage	AC, t=1min		3500		V
CTI	Comparative Tracking Index		250			
Torque	Module-to-Sink	Recommended (M5)	2.5		5	N·m
Torque	Module Electrodes	Recommended (M6)	3		5	N·m
Weight				350		g

Absolute Maximum Ratings ($T_J = 25^\circ\text{C}$, unless otherwise specified)

Symbol	Parameters	Test Conditions	Values	Unit
IGBT				
V_{CES}	Collector - Emitter Voltage	$T_J=25^\circ\text{C}$	1700	V
V_{GES}	Gate - Emitter Voltage		± 20	V
I_C	DC Collector Current	$T_C=25^\circ\text{C}$	325	A
		$T_C=80^\circ\text{C}$	225	A
I_{CM}	Repetitive Peak Collector Current	$t_p=1\text{ms}$	450	A
P_{tot}	Power Dissipation Per IGBT		1400	W
Diode				
V_{RRM}	Repetitive Reverse Voltage	$T_J=25^\circ\text{C}$	1700	V
$I_{F(AV)}$	Average Forward Current	$T_C=25^\circ\text{C}$	225	A
		$T_C=80^\circ\text{C}$	160	A
I_{FRM}	Repetitive Peak Forward Current	$t_p=1\text{ms}$	450	A
I^2t		$T_J = 125^\circ\text{C}$, $t = 10\text{ms}$, $V_R = 0\text{V}$	8200	A^2s

Electrical and Thermal Specifications ($T_J = 25^\circ\text{C}$, unless otherwise specified)

Symbol	Parameters	Test Conditions	Min	Typ	Max	Unit
IGBT						
$V_{GE(th)}$	Gate - Emitter Threshold Voltage	$V_{CE}=V_{GE}, I_C=9\text{mA}$	5.0	5.8	6.4	V
$V_{CE(sat)}$	Collector - Emitter Saturation Voltage	$I_C=225\text{A}, V_{GE}=15\text{V}, T_J=25^\circ\text{C}$		2.0	2.45	V
		$I_C=225\text{A}, V_{GE}=15\text{V}, T_J=125^\circ\text{C}$		2.4		V
I_{CES}	Collector Leakage Current	$V_{CE}=1700\text{V}, V_{GE}=0\text{V}, T_J=25^\circ\text{C}$			3	mA
		$V_{CE}=1700\text{V}, V_{GE}=0\text{V}, T_J=125^\circ\text{C}$			20	mA
I_{GES}	Gate Leakage Current	$V_{CE}=0\text{V}, V_{GE}=\pm 15\text{V}, T_J=125^\circ\text{C}$	-400		400	nA
R_{Gint}	Integrated Gate Resistor			2.8		Ω
Q_{ge}	Gate Charge	$V_{CE}=900\text{V}, I_C=225\text{A}, V_{GE}=\pm 15\text{V}$		2.6		μC
C_{ies}	Input Capacitance	$V_{CE}=25\text{V}, V_{GE}=0\text{V}, f=1\text{MHz}$		20.5		nF
C_{res}	Reverse Transfer Capacitance				0.7	
$t_{d(on)}$	Turn - on Delay Time	$V_{CC}=900\text{V}$ $I_C=225\text{A}$ $R_G=6.2\Omega$ $V_{GE}=\pm 15\text{V}$ Inductive Load	$T_J=25^\circ\text{C}$		280	ns
			$T_J=125^\circ\text{C}$		300	ns
t_r	Rise Time		$T_J=25^\circ\text{C}$		60	ns
			$T_J=125^\circ\text{C}$		75	ns
$t_{d(off)}$	Turn - off Delay Time		$T_J=25^\circ\text{C}$		810	ns
			$T_J=125^\circ\text{C}$		1000	ns
t_f	Fall Time		$T_J=25^\circ\text{C}$		180	ns
			$T_J=125^\circ\text{C}$		300	ns
E_{on}	Turn - on Energy		$T_J=25^\circ\text{C}$		49.5	mJ
			$T_J=125^\circ\text{C}$		71.5	mJ
E_{off}	Turn - off Energy	$T_J=25^\circ\text{C}$		48	mJ	
		$T_J=125^\circ\text{C}$		70.5	mJ	
I_{SC}	Short Circuit Current	$t_{psc} \leq 10\mu\text{s}, V_{GE}=15\text{V}; T_J=125^\circ\text{C}, V_{CC}=1000\text{V}$		900		A
R_{thJC}	Junction-to-Case Thermal Resistance (Per IGBT)				0.09	K/W
Diode						
V_F	Forward Voltage	$I_F=225\text{A}, V_{GE}=0\text{V}, T_J=25^\circ\text{C}$		1.8	2.2	V
		$I_F=225\text{A}, V_{GE}=0\text{V}, T_J=125^\circ\text{C}$		1.9		V
I_{RRM}	Max. Reverse Recovery Current	$I_F=225\text{A}, V_R=900\text{V}$ $di_F/dt=-2900\text{A}/\mu\text{s}$ $T_J=125^\circ\text{C}$		285		A
Q_{rr}	Reverse Recovery Charge			98		μC
E_{rec}	Reverse Recovery Energy			54		mJ
R_{thJCD}	Junction-to-Case Thermal Resistance (Per Diode)				0.16	K/W

NTC Characteristics ($T_J = 25^\circ\text{C}$, unless otherwise specified)

Symbol	Parameters	Test Conditions	Min	Typ	Max	Unit
R_{25}	Resistance	$T_c=25^\circ\text{C}$		5		K Ω
$B_{25/50}$				3375		K

Figure 1: Typical Output Characteristics for IGBT Inverter

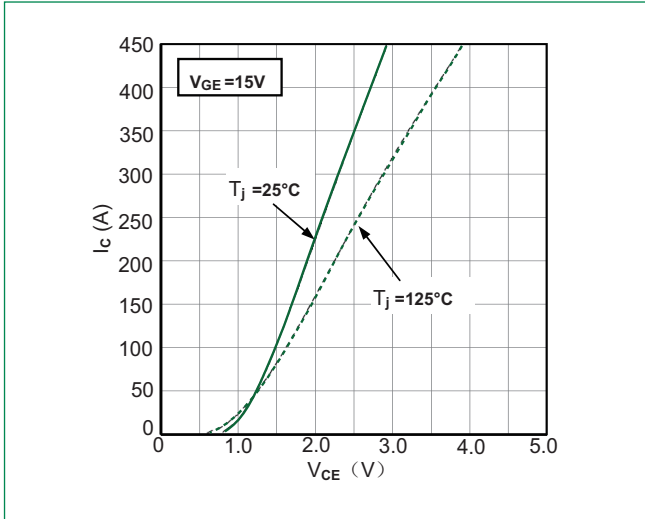

Figure 2: Typical Output Characteristics for IGBT Inverter

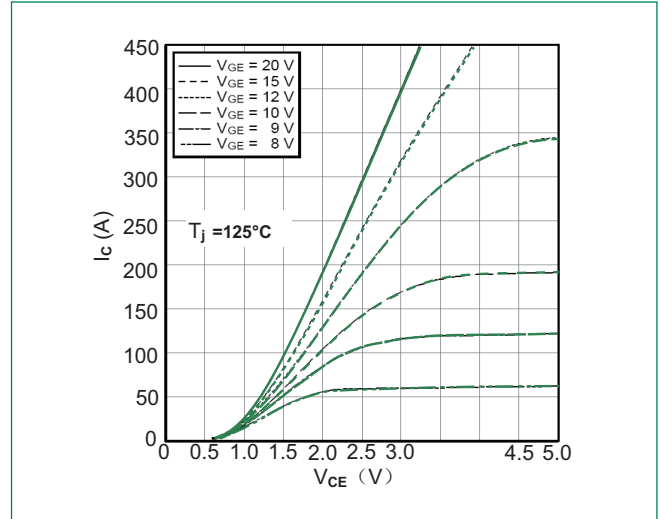

Figure 3: Typical Transfer Characteristics for IGBT Inverter

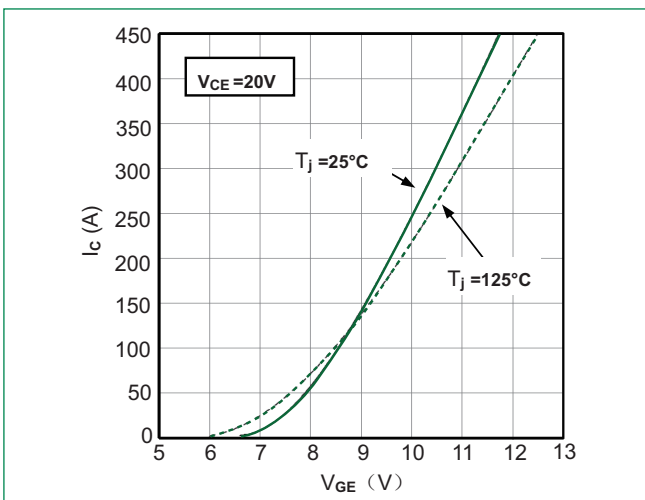

Figure 4: Switching Energy vs. Gate Resistor for IGBT Inverter

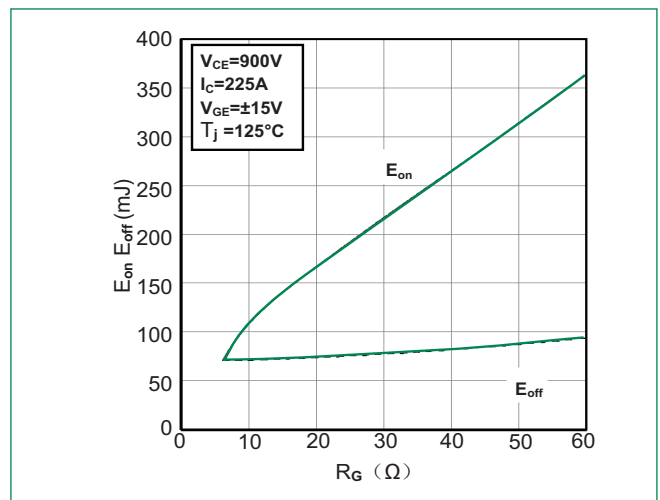

Figure 5: Switching Energy vs. Collector Current for IGBT Inverter

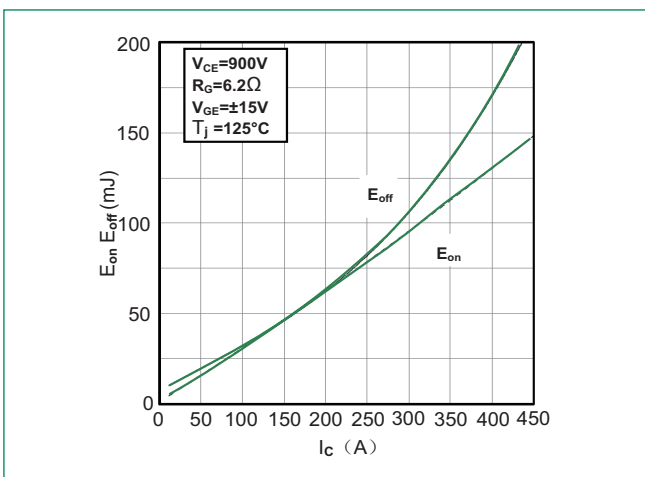

Figure 6: Reverse Biased Safe Operating Area for IGBT Inverter

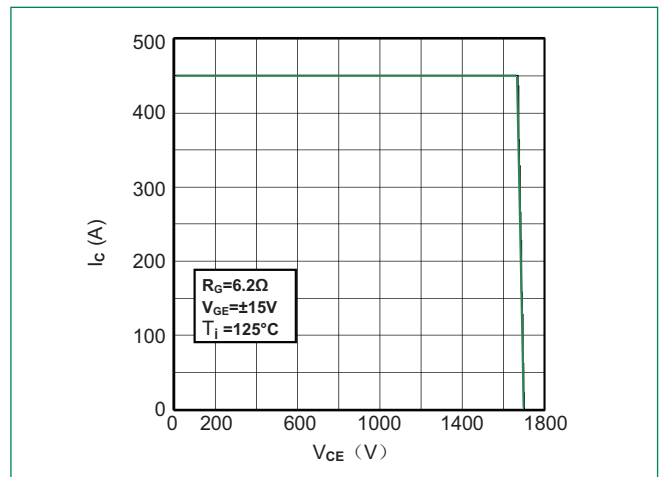

Figure 7: Diode Forward Characteristics for Diode Inverter

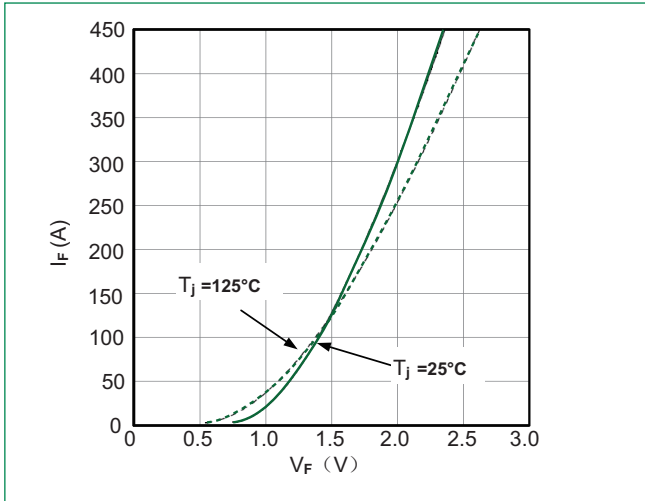

Figure 8: Switching Energy vs. Gate Resistort for Diode Inverter

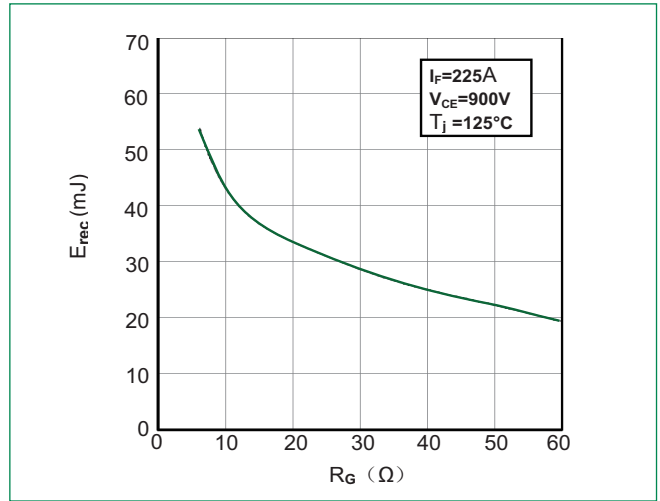

Figure 9: Transient Thermal Impedance of Diode and IGBT Inverter

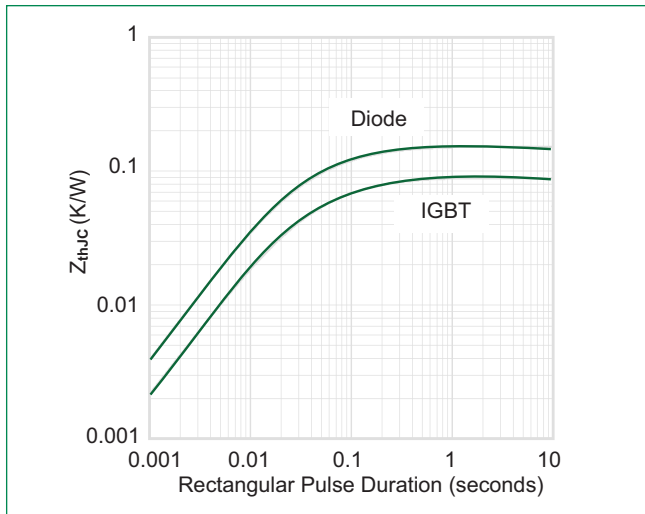
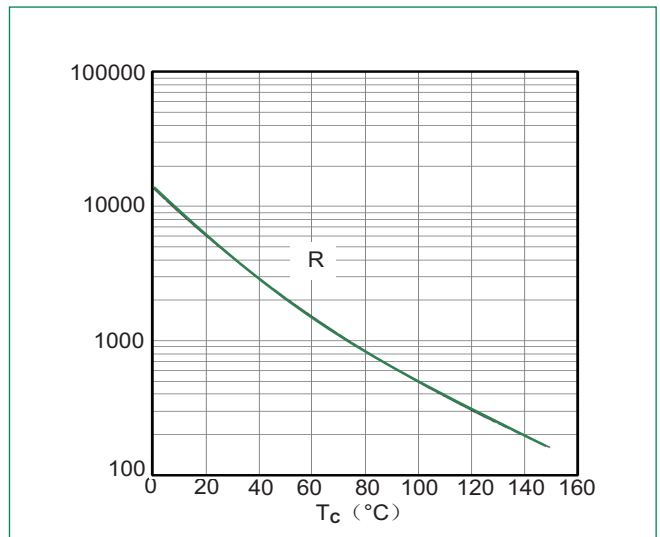

Figure 10: NTC Characteristics



Circuit Diagram



Dimensions-Package WB

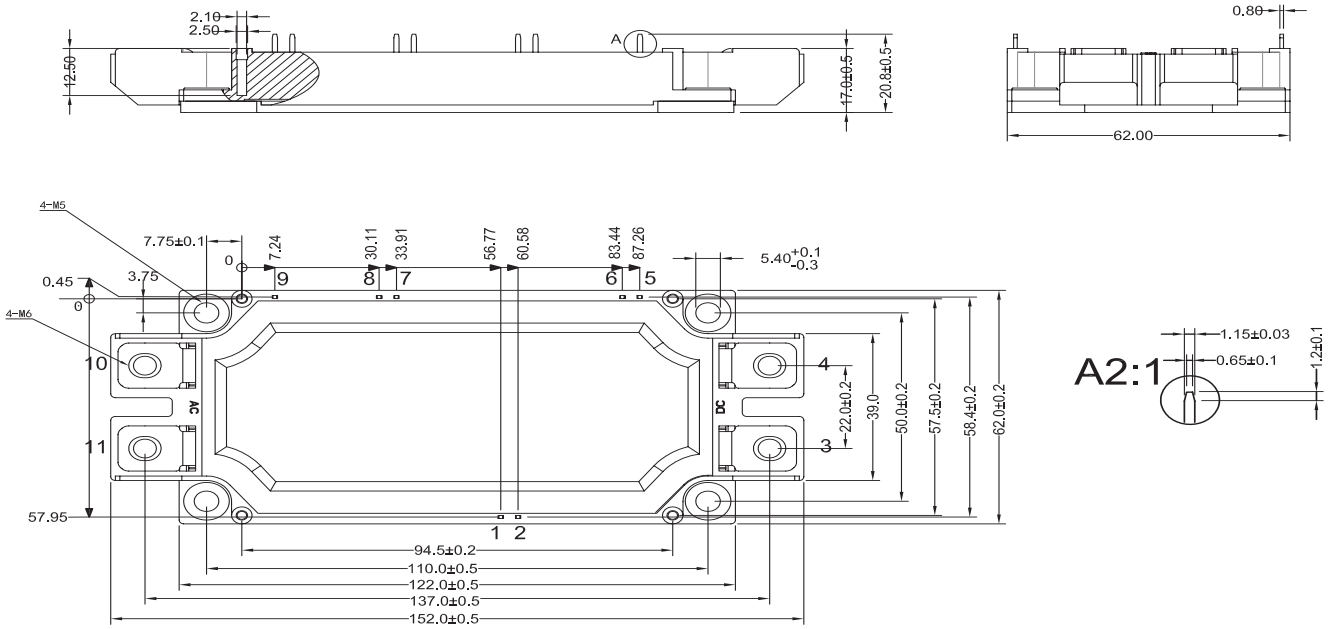

The foot pins are in gold / nickel coating

Packing Options

Part Number	Marking	Weight	Packing Mode	M.O.Q
MG17225WB-BN4MM	MG17225WB-BN4MM	350g	Bulk Pack	20

Part Numbering System

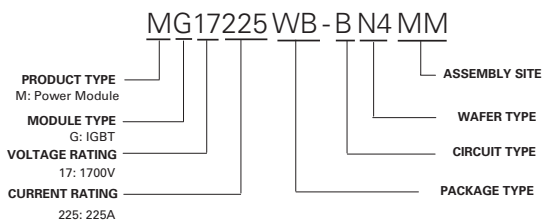

Part Marking System

