

CANSTACK LINEAR ACTUATORS

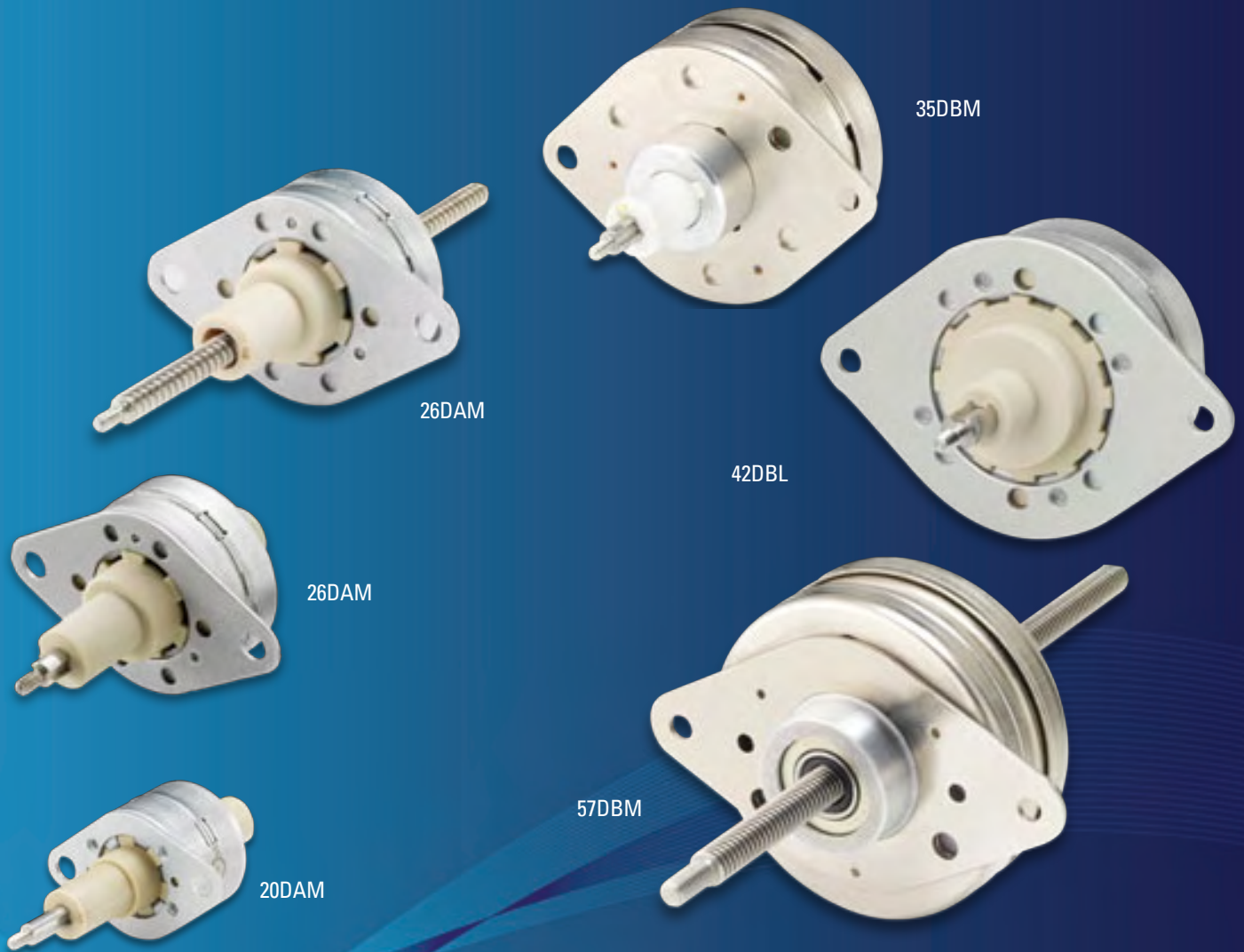

Portescap can trace its roots back to the team who invented the first digital linear actuator. Today, this technology is found in a growing variety of applications for very good reasons – they cost effectively provide linear motion with high degrees of accuracy. Portescap has a wide range of actuators ranging from 20 to 57mm diameter providing over 120N of force.

Portescap

WHY A CANSTACK VECTOR	156
WHAT IS A CANSTACK VECTOR	157
HOW TO SELECT YOUR CANSTACK VECTOR	159
WHERE TO APPLY YOUR CANSTACK VECTOR	162
SPECIFICATIONS	164

MOTION SOLUTIONS THAT MOVE LIFE FORWARD.™



WHY A CANSTACK VECTOR

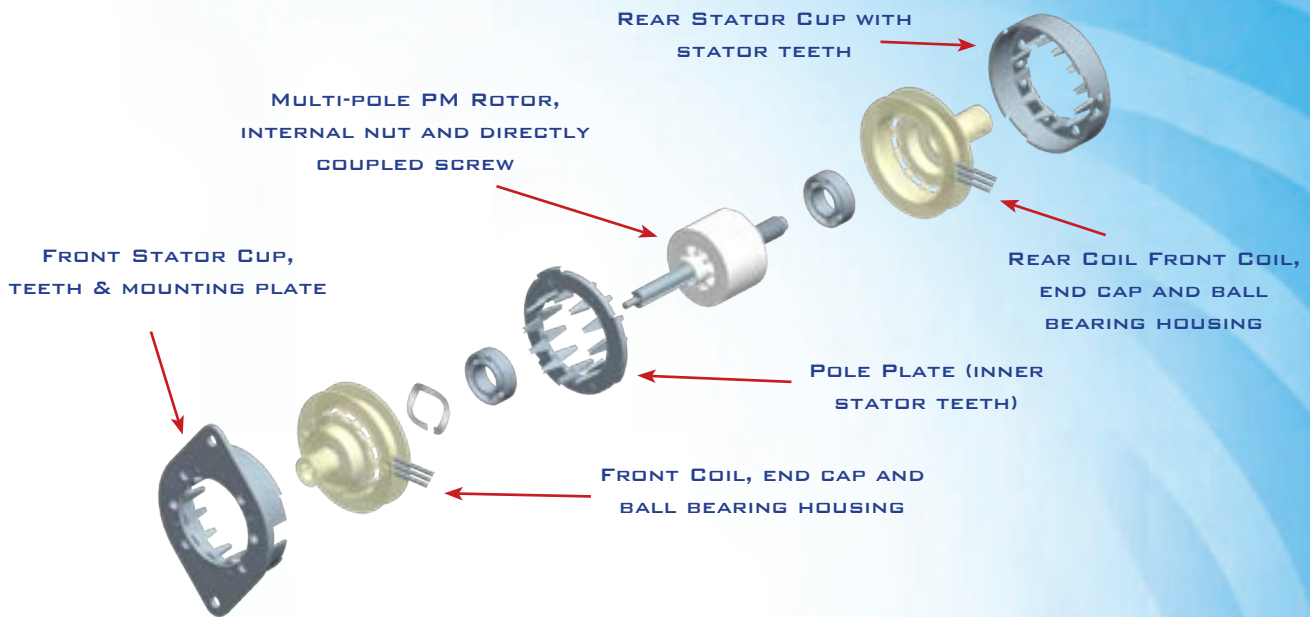

In today's business environment, there is often a critical need to customize motion solutions to allow for easier integration into the machine and to reduce the overall assembly time of the application. Portescap takes this principle to the next level by providing the electromechanical conversion from rotary to linear motion through the CanStack Vector digital linear actuator series.

CanStack Vector customers typically realize space and cost savings over their previous motion solutions through the elimination of mechanical components such as gears, belts and separate threaded shafts or screws. This lowers the total cost of ownership in the system while providing increased performance and reliability. In many cases, Portescap can also combine the power of the CanStack Vector technology with additional value engineering services to create a complete integrated actuation system for your machine.

STANDARD FEATURES

- Reversible
- Captive or non-captive versions
- Unipolar or bipolar designs
- All capable of micro-stepping
- Ball bearings
- RoHS compliant

CUSTOM DESIGNS FOR IMPROVED PERFORMANCE AND INTEGRATION

- Coil Modifications – resistance and inductance
- Magnets – to yield higher linear force or reduced detent levels
- Higher strength plastics for greater impact forces
- Reduced or increased detent force to suit application
- Custom lead screw – metric or imperial tips, length
- Special flanges
- Connector options
- Lead length, shrink tubing
- End of motion detection sensors
- Geared linear actuator
- Needle valve assemblies

WHAT IS A CANSTACK VECTOR?

A CanStack Vector is a step motor with a built-in leadscrew which translates rotary to linear movement

- The actuator uses the basic CanStack PM stepper motor design and uses either a 7.5 or 15 degree step angle
- The neodymium rotor magnet sits on a thermoplastic nut captured between two ball bearings secured in the end caps
- There are two basic types of linear actuators - Captive and Non-captive



Non-Captive Linear Actuator

- The resultant motion is linear but the screw also rotates and anti-rotation is within the customer's application.

Captive Linear Actuator

- The shaft is a two piece construction
- The rear section is a leadscrew and rotates through the nut
- The front section is a grooved shaft
- This engages with a "butterfly" plastic end cap
- This acts as an anti-rotation device
- The resultant motion is a pushing action with no rotation



ADVANTAGES

As the step error is non-cumulative, good accuracies are achieved across long or short travel distances meaning costly positional feedback devices such as encoders can be eliminated. Motors can be operated in single step, half step or micro stepping modes leading to improved accuracies, more force developed and quieter operation.

- Excellent open loop control. No encoders necessary
- High continuous linear force output per in³
- Digitally controlled. Easy to use with a micro processor
- Cost effective, compact design with lower integration costs
- Motors driven from same source maintain synchronism
- Maintenance free – motor is brushless
- Closed loop complications avoided with reasonable positional accuracy
- Unipolar and bipolar winding possibilities
- End of position sensors or position sensors possible
- Uses standard tin can (can stack) frame size – making integration easier
- Tip of screw is threaded for easy connection and adaptors can be added to get M2 or M3 threads to join with the load



INNOVATION & PERFORMANCE

CanStack PM Stepper

Linear Movement -
Directly Coupled

Fewer mechanical
components

Higher performance
Easier to integrate
Less inventory items
Longer machine life
Lower cost of ownership

Our 7.5 or 15 degree actuators drive an integrated threaded screw through the body of the motor via a rotor magnet and threaded nut assembly to provide linear motion within the machine. Portescap's CanStack Vectors are available in frame sizes from 20 to 57mm with various resolutions and deliver from 11 to 121 N of linear force. We also have geared linear actuator units where a built-in gear delivers higher forces and greater accuracies with resolutions down to a few microns per step. AC synchronous versions are also available. Portescap will eagerly advise the best actuator choice for your application.

In addition to the advantages of the CanStack Vector technology, Portescap can also help you to take your application to the next level by exploring even more complex designs to further improve the integration and reduce the total assembly time of your entire motion system. Our experienced team of design engineers can customize to exceed your motion performance specifications, simplify your design and develop a "plug and play" integrated actuation system for your machine. For this reason, Portescap is often chosen by many of today's leading device manufacturers in the Medical, Lab Automation, HVAC&R and Security & Access industries.



CANSTACK VECTOR DESIGNATION

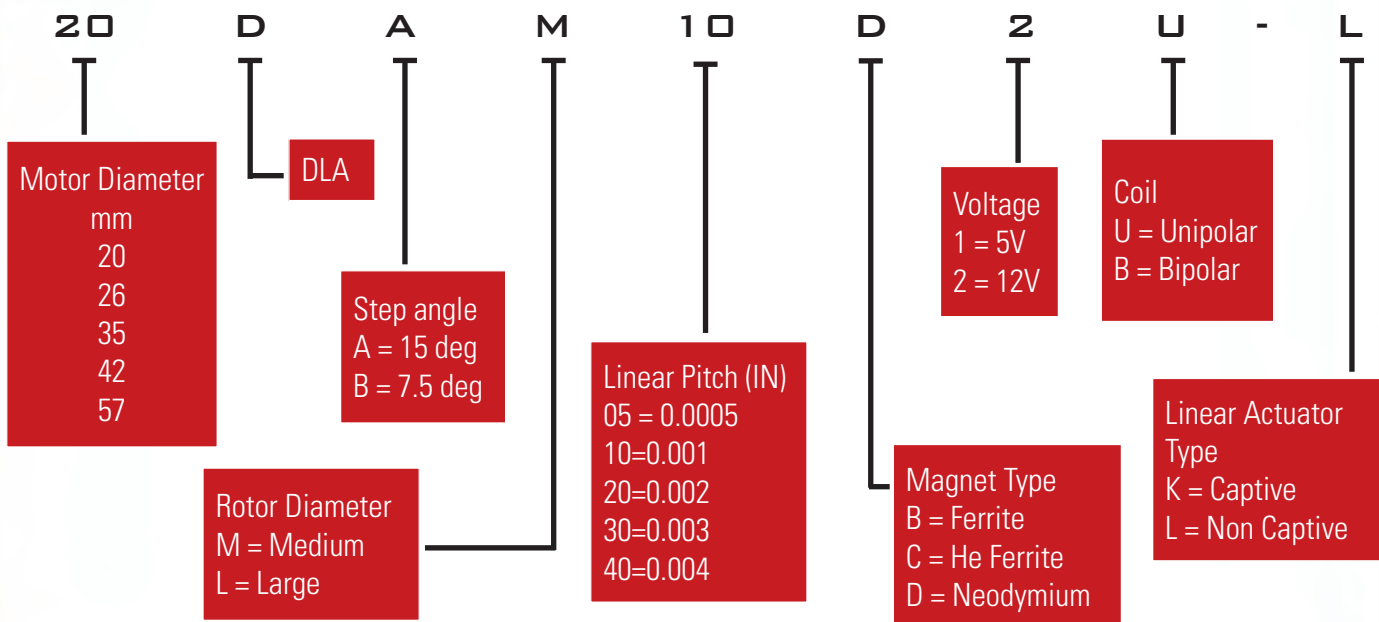

HOW TO SELECT YOUR LINEAR ACTUATOR

- Linear force – speed curves are the key to selecting the right motor and control drive method for a specific application.
- Define your application load – speed required, load inertia and force required, and accuracy needed.
- If the application requires no acceleration, then use the pull out force.
- If the load is inertial, acceleration is required, it is advisable to use pull in force.
- Use a 1.5 to 2 times margin over the maximum torque required.
- Leave some distance at either end of travel to avoid impact damage at the maximum travel or stroke. The force on the shaft, when fully extended, has to be supported by the number of threads in contact with the nut. This can be a limiting factor.
- Choosing the correct drive is important. For example micro-stepping drives will provide quieter operation. Like all steppers – a linear actuator will deliver force dependent on the drive – L/R , Chopper, 24 or 36V
- Remember – if it is not in the catalog – it does not mean that we cannot provide a solution - Portescap may still be able to provide you what you want as our team can draw from a wealth of customized designs created over the past 20 years of linear actuator designs.

SERIES	Linear Travel Per Step (mm/in)	Maximum Force (N / oz)	Min. Holding Force (Un-energized) (N / oz)	DC Operating Voltage	Resistance/Windings (Ohms) Bipolar & Unipolar	
					5 VDC	12 VDC
20DAM-K&-L	0.0254 / .0010	30/108	55.6/200	5 or 12	20	115.2
	0.0508 / .0020	20.9/75	11.1/40	5 or 12	20	115.2
	0.1018/.0040	11.1/40	2.8/10	5 or 12	20	115.2
26DBM-K & -L	0.0127 / .0005	16.7 / 60	55.6 / 200	5 or 12	14.6	84
	0.0254 / .0010	13.3 / 48	13.9 / 50	5 or 12	14.6	84
	0.0508 / .0020	8.9 / 32	2.8 / 10	5 or 12	14.6	84
26DAM-K&-L	0.0254 / .0010	33.4 / 120	55.6 / 200	5 or 12	14.6	84
	0.0508 / .0020	25 / 90	19.5 / 70	5 or 12	14.6	84
	0.1018/.0040	14.5 / 52	8.3 / 30	5 or 12	14.6	84
35DBM-K & -L	0.0254 / .0010	20.9 / 75	11.1 / 40	5 or 12	10	58
	0.0508 / .0020	15.3 / 55	2.8 / 10	5 or 12	10	58
	0.0762 / .0030	8.3 / 30	1.4 / 5	5 or 12	10	58
42DBL-K & -L	0.0254 / .0010	100.0 / 360	111.2 / 400	5 or 12	5	28.8
	0.0508 / .0020	72.3 / 260	83.4 / 300	5 or 12	5	28.8
	0.1016 / .0040	50.0 / 180	19.5 / 70	5 or 12	5	28.8
57DBM -L	0.0254 / .0010	124.6 / 448	88 / 320	5 or 12	4.3	25
	0.0508 / .0020	102.4 / 368	71 / 256	5 or 12	4.3	25



EXPLANATION OF SPECIFICATIONS

MOTOR PART NUMBER	SCREW PITCH	26DAMXXD1B-K		EXPLANATION
RATED VOLTAGE		vdc	5.00	Voltage rating of motor - motor can be run continuously at this voltage
RESISTANCE PER PHASE, ± 10%		ohms	14.60	Winding resistance dictated by magnet wire diameter and # of turns
INDUCTANCE PER PHASE, TYP		mH	6.50	Winding inductance dictated by magnet wire diameter and # of turns
RATED CURRENT PER PHASE *		amps	0.34	Current rating of motor - motor can be run continuously at this current
MAXIMUM FORCE	.001" (0.0254mm)	oz / N	120 / 33.4	When energized, the amount of force to move from one mechanical step to the next
	.002" (0.0508mm)		90 / 25	When energized, the amount of force to move from one mechanical step to the next
	.004" (0.1016mm)		52 / 14.5	When energized, the amount of force to move from one mechanical step to the next
MINIMUM FORCE (UNENERGIZED)	.001" (0.0254mm)	oz / N	200 / 55.6	When un-energized, the amount of force to move from one mechanical step to the next
	.002" (0.0508mm)		70 / 19.5	When un-energized, the amount of force to move from one mechanical step to the next
	.004" (0.1016mm)		30 / 8.3	When un-energized, the amount of force to move from one mechanical step to the next
MAXIMUM TRAVEL	.001" (0.0254mm)	in / mm	0.52 / 13.2	Length of maximum movement of lead screw
	.002" (0.0508mm)		0.52 / 13.2	Length of maximum movement of lead screw
	.004" (0.1016mm)		0.52 / 13.2	Length of maximum movement of lead screw
STEP ANGLE, ± 5% *		degrees	15.0	360 deg / number of mechanical steps of the motor
STEPS PER REVOLUTION *		-	24	Number of mechanical steps of the motor
THERMAL RESISTANCE		°C/watt	N.A	
AMBIENT TEMPERATURE RANGE	OPERATING	°C	-20 ~ +70	Temperature range which the motor will operate
	STORAGE	°C	-40 ~ +85	Storage temperature where the motor will operate
BEARING TYPE		-	BALL BEARING	
INSULATION RESISITANCE AT 500VDC		Mohms	20 MEGOHMS	
DIELECTRIC WITHSTANDING VOLTAGE		vac	650 FOR 2 SECONDS	
WEIGHT		lbs / g	0.075 / 34	Weight of the motor
SHAFT LOAD RATINGS	RADIAL	lbs / kg	.055 / .025	Maximum load that can be applied against the shaft
	AXIAL		.055 / .025	Maximum load that can be applied directly down the shaft
LEADWIRES			AWG 28, UL 1429	Rating of the lead wires
TEMPERATURE CLASS, MAX			B (130°C)	Maximum temperature of the winding insulation
RoHS			COMPLIANT	

ALL MOTOR DATA VALUES AT 25 °C UNLESS OTHERWISE SPECIFIED

* ENERGISE AT RATED CURRENT, 2 PHASE ON

20DAMXXDXB-K/L
TYPICAL PULL-IN LINEAR FORCE VS LINEAR RATE AT 20°C
FULL STEP, BIPOLAR, L/R DRIVE

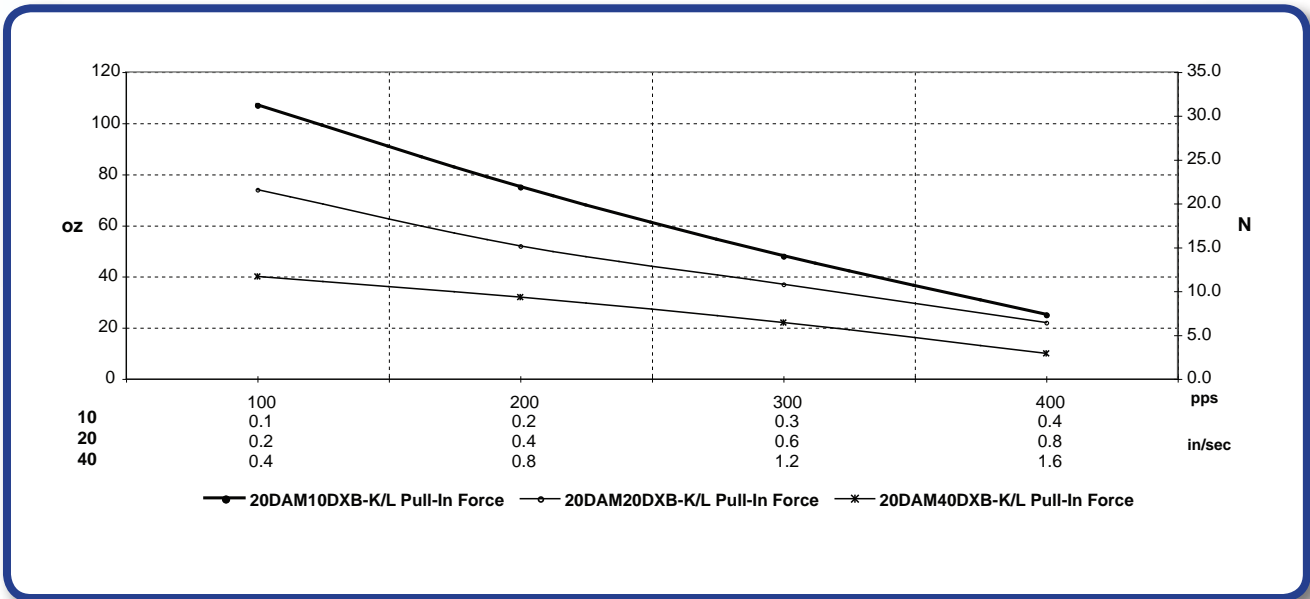

DEFINITIONS

- Pull-In Force** The amount of force that the motor can produce from zero speed without stalling

- Speed** # of pulses per second provided to the motor, also stated in revolutions per minute

- Voltage** Voltage applied to the drive

- Current** Current applied to the drive

- Drive** Chopper type drive - current controlled to the motor winding



WHERE TO APPLY YOUR CANSTACK VECTOR



FOCUS ON: SECURITY & ACCESS

Bank Safe Delayed Locking Mechanism – Challenged to provide a compact, high force rugged time-delay and locking mechanism, Portescap offered a CanStack Vector actuator, 20mm in diameter that could withstand high shock loads. The thermoplastic nut and end caps were modified to survive impact forces greatly exceeding the application's requirements, resulting in a smaller lock. Fully integrated with an end of travel sensor, special coil design, and special leads and a connector, this fully customized motor was exactly what the customer needed: compact, shock resistant and extremely cost effective.



HEATING, VENTILATION, AIR-CONDITIONING & REFRIGERATION (HVAC&R)

- Variable air valve
- Flap & damper actuators
- Gas valve actuation systems
- Heating & air-conditioning systems & pumps
- Refrigeration valve actuation systems
- Heating valve actuation systems



OFFICE AUTOMATION

- Printers
- Data storage units
- Copiers
- Paper feed devices



MEDICAL & LAB AUTOMATION

- Pipettes
- Pill dispensing
- Infusion pumps & dosing pumps
- Portable analyzers and printers
- Automated pharmacy systems
- Blood & plasma analyzers



TELECOMMUNICATION

- Antenna positioning
- Cellular phone masts & arrays

Notes

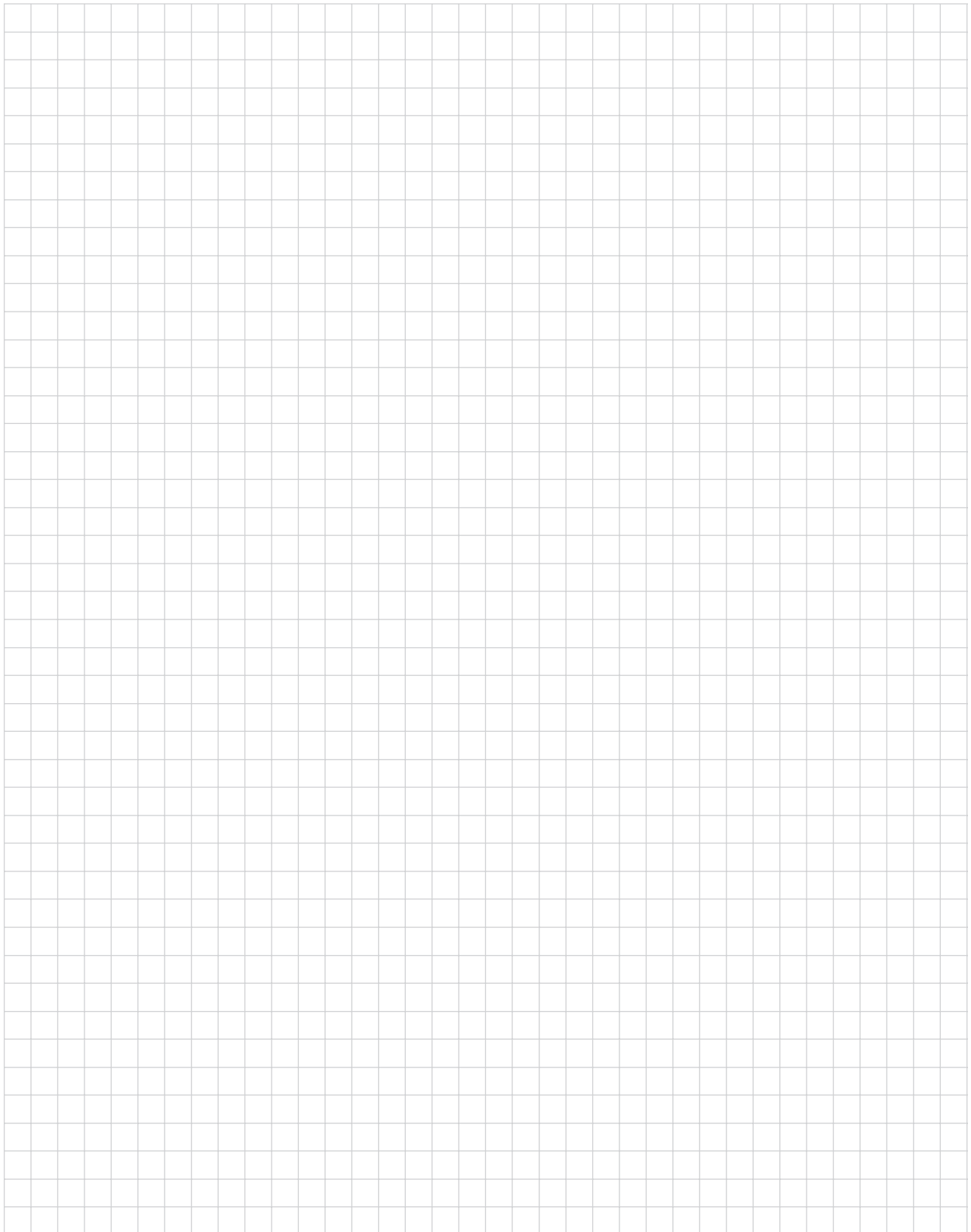

20DAM-L

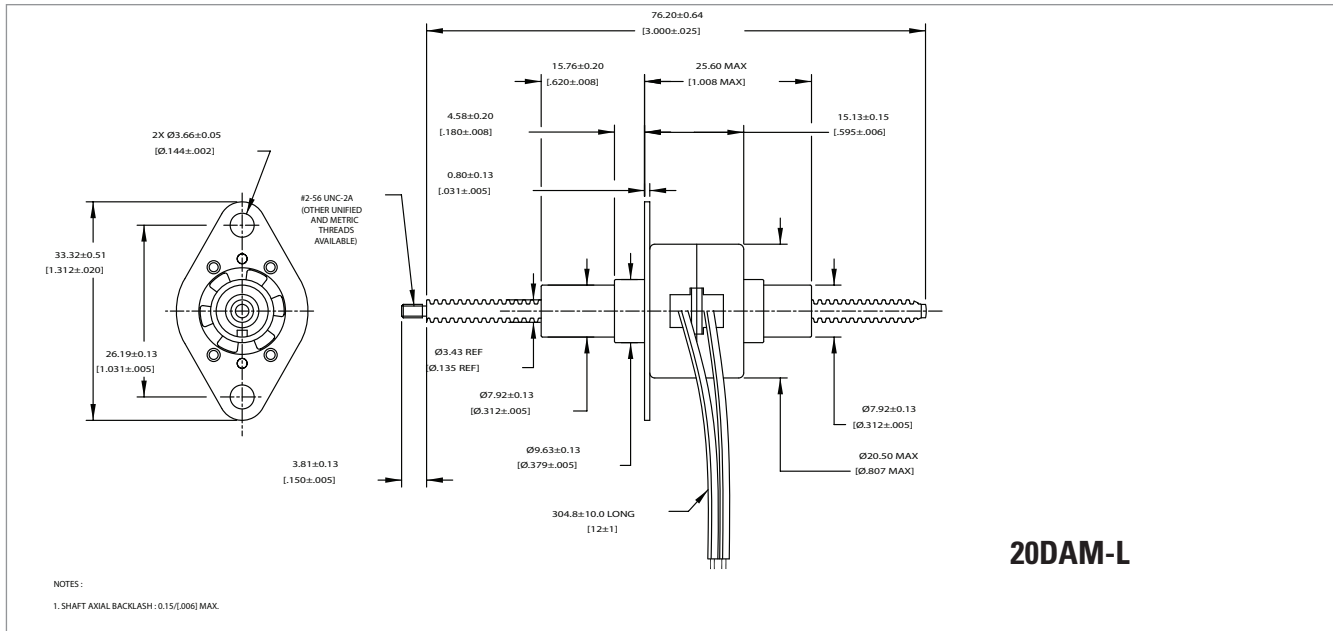

20DAM-L

Motor Part Number		20DAMXXD1B-L	20DAMXXD2B-L
Rated voltage	vdc	5.00	12.00
Resistance per phase, ± 10%	ohms	20.00	115.20
Inductance per phase, typ	mH	7.20	40.80
Rated current per phase *	amps	0.25	0.10
Maximum force	.001" (0.0254mm) .002" (0.0508mm) .004" (0.1016mm)	oz / N	110 / 30.6 75 / 20.9 40 / 11.1
Minimum holding force (unenergized)	.001" (0.0254mm) .002" (0.0508mm) .004" (0.1016mm)	oz / N	200 / 55.6 40 / 11.1 10 / 2.8
Maximum travel	.001" (0.0254mm) .002" (0.0508mm) .004" (0.1016mm)	in / mm	1.97 / 50.0 1.97 / 50.0 1.97 / 50.0
Step angle, ± 1° *		degrees	15.00
Steps per revolution *			24
Thermal resistance		°C/watt	N.A.
Ambient temperature range			
Operating		°C	-20 ~ +70
Storage		°C	-40 ~ +85
Bearing type			Ball bearing
Insulation resistance at 500vdc		Mohms	20 megohms
Dielectric withstanding voltage		vac	650 for 2 seconds
Weight		lbs / g	0.055 / 25
Leadwires			AWG28, UL 1429
Temperature class, max			B (130°C)
RoHS			COMPLIANT

ALL MOTOR DATA VALUES AT 20°C UNLESS OTHERWISE SPECIFIED
* ENERGISE AT RATED CURRENT, 2 PHASE ON, L/R Drive

20DAM-L

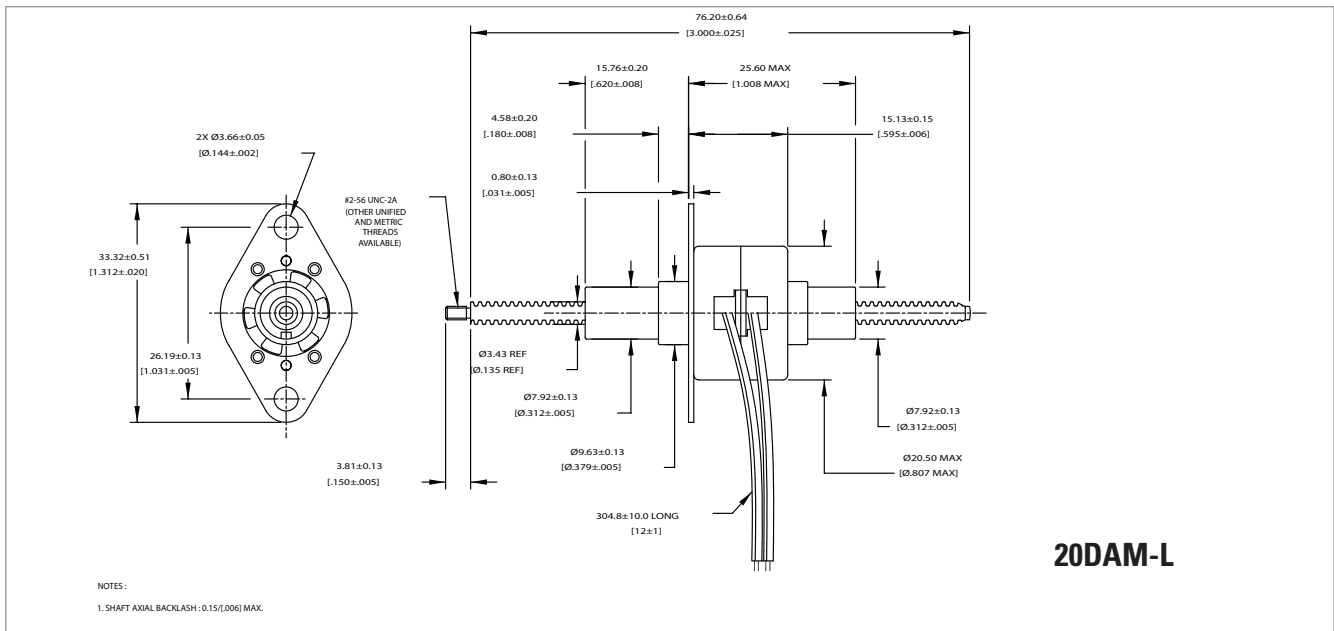

Motor Part Number		20DAMXXD1U-L	20DAMXXD2U-L
Rated voltage	vdc	5.00	12.00
Resistance per phase, ± 10%	ohms	20.00	115.20
Inductance per phase, typ	mH	3.80	20.30
Rated current per phase *	amps	0.25	0.10
Maximum force	.001" (0.0254mm) .002" (0.0508mm) .004" (0.1016mm)	oz / N	75 / 20.9 50 / 13.9 30 / 8.3
Minimum holding force (unenergized)	.001" (0.0254mm) .002" (0.0508mm) .004" (0.1016mm)	oz / N	200 / 55.6 40 / 11.1 10 / 2.8
Maximum travel	.001" (0.0254mm) .002" (0.0508mm) .004" (0.1016mm)	in / mm	1.97 / 50.0 1.97 / 50.0 1.97 / 50.0
Step angle, ± 1° *		degrees	15.00
Steps per revolution *			24
Thermal resistance		°C/watt	N.A.
Ambient temperature range			
Operating		°C	-20 ~ +70
Storage		°C	-40 ~ +85
Bearing type			Ball bearing
Insulation resistance at 500vdc		Mohms	20 megohms
Dielectric withstanding voltage		vac	650 for 2 seconds
Weight		lbs / g	0.055 / 25
Leadwires			AWG28, UL 1429
Temperature class, max			B (130°C)
RoHS			COMPLIANT

ALL MOTOR DATA VALUES AT 20°C UNLESS OTHERWISE SPECIFIED
* ENERGISE AT RATED CURRENT, 2 PHASE ON , L/R Drive

20DAM-K

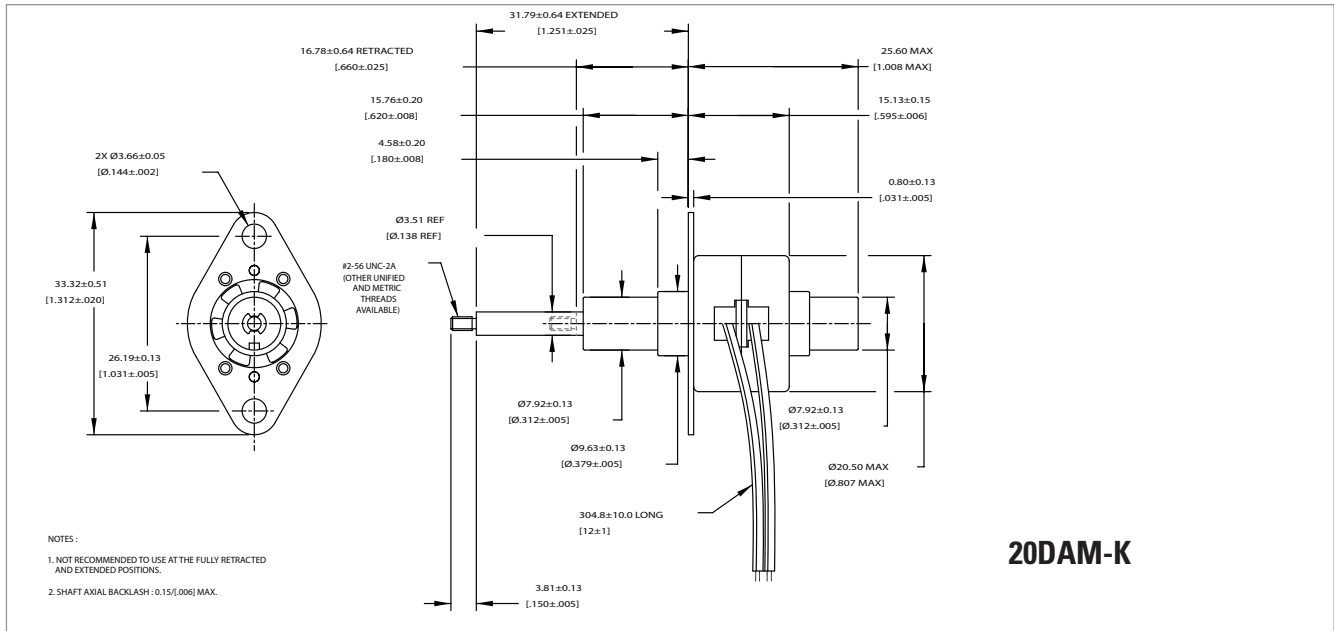

20DAM-K

Motor Part Number		20DAMXXD1B-K	20DAMXXD2B-K
Rated voltage	vdc	5.00	12.00
Resistance per phase, ± 10%	ohms	20.00	115.20
Inductance per phase, typ	mH	7.20	40.80
Rated current per phase *	amps	0.25	0.10
Maximum force	.001" (0.0254mm) .002" (0.0508mm) .004" (0.1016mm)	oz / N	110 / 30.6 75 / 20.9 40 / 11.1
Minimum holding force (unenergized)	.001" (0.0254mm) .002" (0.0508mm) .004" (0.1016mm)	oz / N	200 / 55.6 40 / 11.1 10 / 2.8
Maximum travel	.001" (0.0254mm) .002" (0.0508mm) .004" (0.1016mm)	in / mm	0.59 / 15.0 0.59 / 15.0 0.59 / 15.0
Step angle, ± 1° *		degrees	15.00
Steps per revolution *			24
Thermal resistance		°C/watt	N.A.
Ambient temperature range			
Operating		°C	-20 ~ +70
Storage		°C	-40 ~ +85
Bearing type			Ball bearing
Insulation resistance at 500vdc		Mohms	20 megohms
Dielectric withstanding voltage		vac	650 for 2 seconds
Weight		lbs / g	0.055 / 25
Leadwires			AWG28, UL 1429
Temperature class, max			B (130°C)
RoHS			COMPLIANT

ALL MOTOR DATA VALUES AT 20°C UNLESS OTHERWISE SPECIFIED
* ENERGISE AT RATED CURRENT, 2 PHASE ON, L/R Drive

20DAM-K

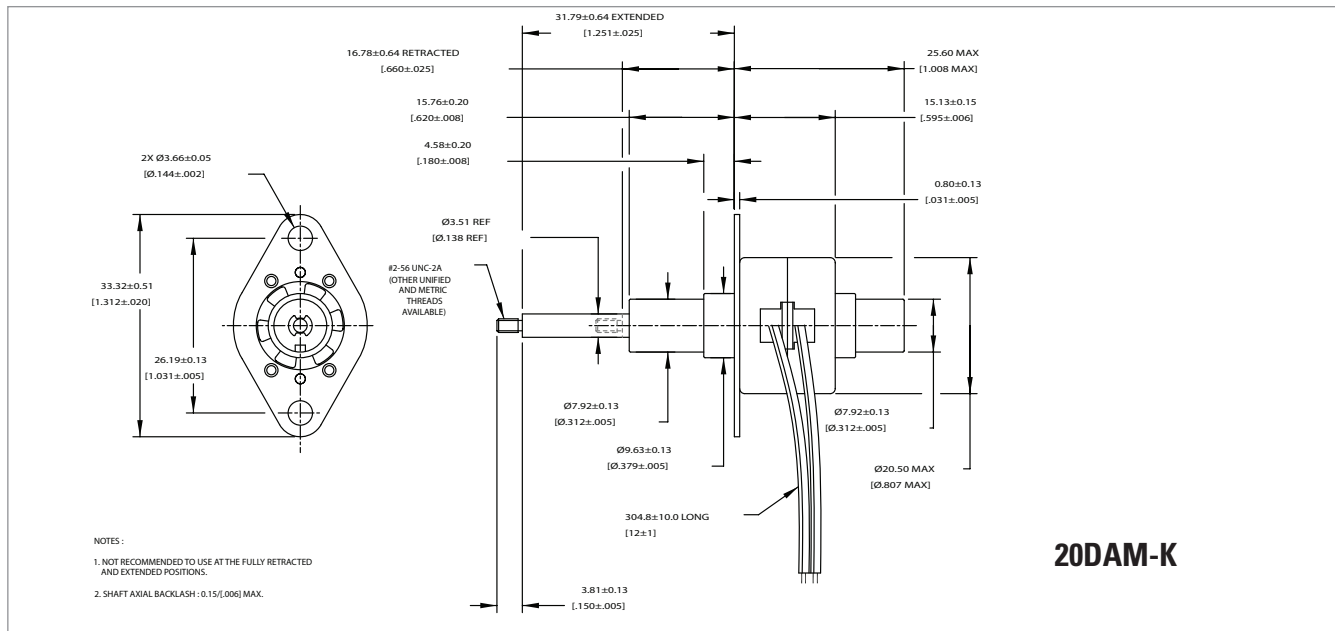

20DAM-K

Motor Part Number		20DAMXXD1U-K	20DAMXXD2U-K
Rated voltage	vdc	5.00	12.00
Resistance per phase, ± 10%	ohms	20.00	115.20
Inductance per phase, typ	mH	3.80	20.30
Rated current per phase *	amps	0.25	0.10
Maximum force	.001" (0.0254mm) .002" (0.0508mm) .004" (0.1016mm)	oz / N	75 / 20.9 50 / 13.9 30 / 8.3
Minimum holding force (unenergized)	.001" (0.0254mm) .002" (0.0508mm) .004" (0.1016mm)	oz / N	200 / 55.6 40 / 11.1 10 / 2.8
Maximum travel	.001" (0.0254mm) .002" (0.0508mm) .004" (0.1016mm)	in / mm	0.59 / 15.0 0.59 / 15.0 0.59 / 15.0
Step angle, ± 1° *		degrees	15.00
Steps per revolution *			24
Thermal resistance		°C/watt	N.A.
Ambient temperature range			
Operating		°C	-20 ~ +70
Storage		°C	-40 ~ +85
Bearing type			Ball bearing
Insulation resistance at 500vdc		Mohms	20 megohms
Dielectric withstanding voltage		vac	650 for 2 seconds
Weight		lbs / g	0.055 / 25
Leadwires			AWG28, UL 1429
Temperature class, max			B (130°C)
RoHS			COMPLIANT

Stepper

ALL MOTOR DATA VALUES AT 20°C UNLESS OTHERWISE SPECIFIED
* ENERGISE AT RATED CURRENT, 2 PHASE ON, L/R Drive

26DAM-L

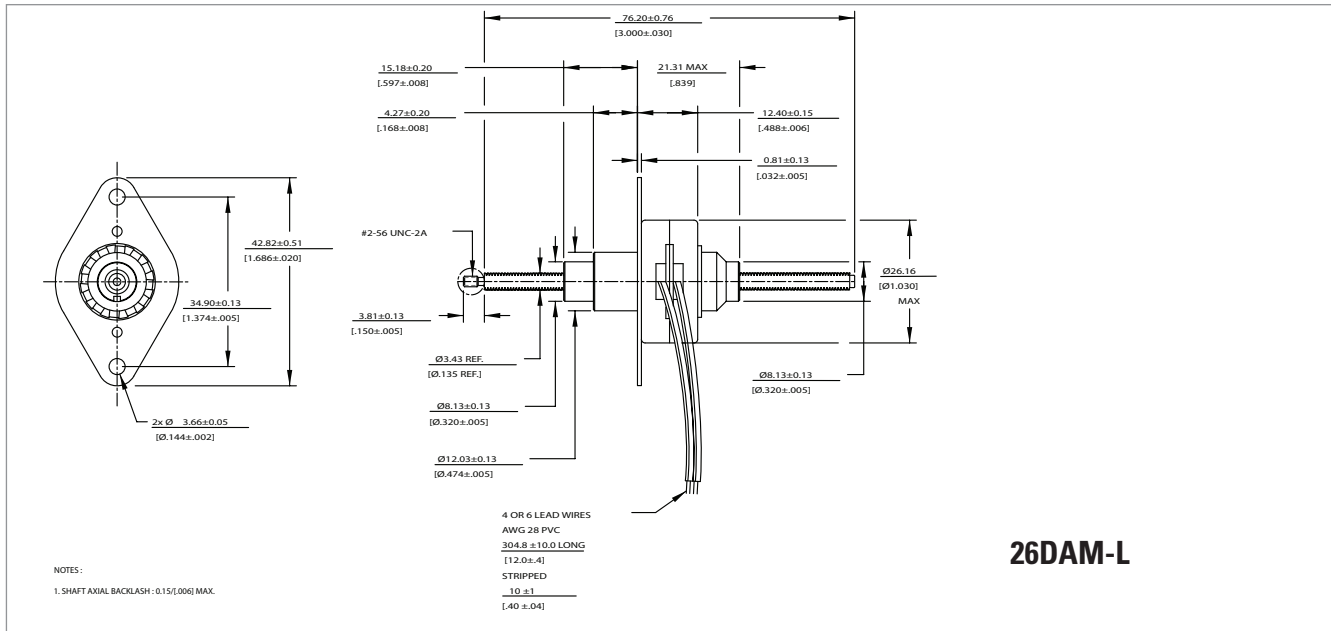

Motor Part Number		26DAMXXD1B-L	26DAMXXD2B-L
Rated voltage	vdc	5.00	12.00
Resistance per phase, ± 10%	ohms	14.60	84.00
Inductance per phase, typ	mH	6.50	33.60
Rated current per phase *	amps	0.34	0.14
Maximum force	.001" (0.0254mm) .002" (0.0508mm) .004" (0.1016mm)	oz / N	120 / 33.4 90 / 25 52 / 14.5
Minimum holding force (unenergized)	.001" (0.0254mm) .002" (0.0508mm) .004" (0.1016mm)	oz / N	200 / 55.6 50 / 13.9 20 / 5.5
Maximum travel	.001" (0.0254mm) .002" (0.0508mm) .004" (0.1016mm)	in / mm	1.89 / 48.0 1.89 / 48.0 1.89 / 48.0
Step angle, ± 1° *		degrees	15.00
Steps per revolution *			24
Thermal resistance		°C/watt	N.A.
Ambient temperature range			
Operating		°C	-20 ~ +70
Storage		°C	-40 ~ +85
Bearing type			Ball bearing
Insulation resistance at 500vdc		Mohms	20 megohms
Dielectric withstanding voltage		vac	650 for 2 seconds
Weight		lbs / g	0.075 / 34
Leadwires			AWG 28, UL 1429
Temperature class, max			B (130°C)
RoHS			COMPLIANT

ALL MOTOR DATA VALUES AT 20°C UNLESS OTHERWISE SPECIFIED
 * ENERGISE AT RATED CURRENT, 2 PHASE ON, L/R Drive

26DAM-L

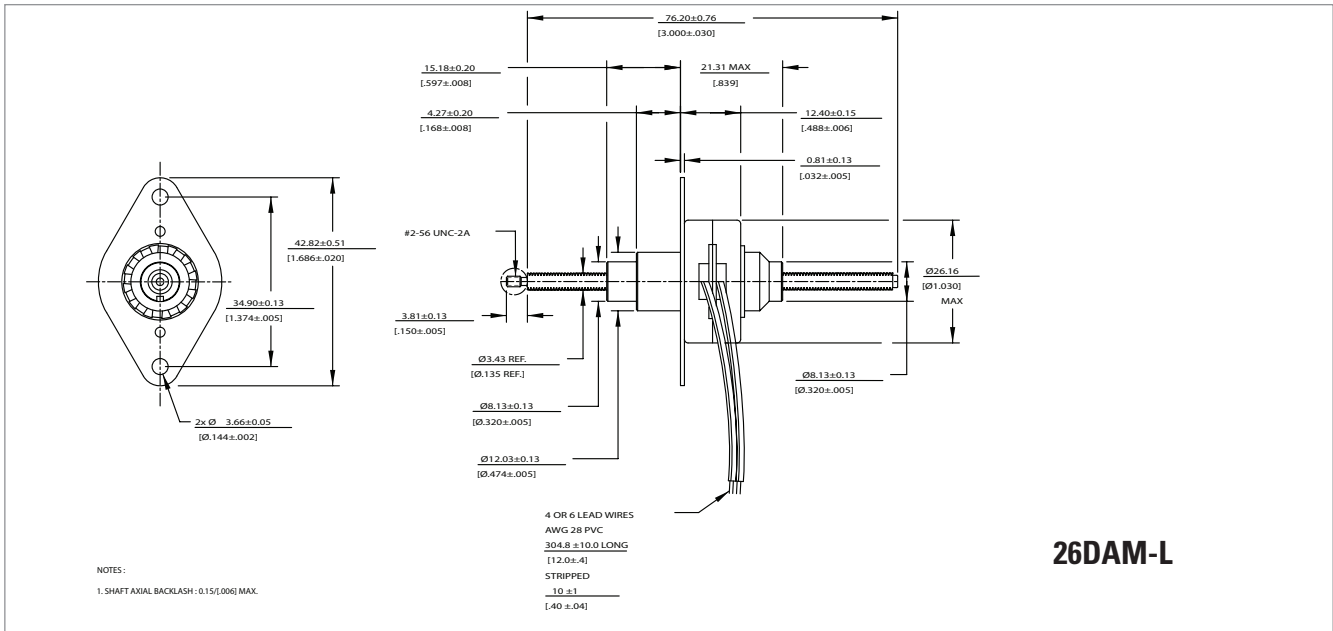

26DAM-L

Motor Part Number		26DAMXXD1U-L	26DAMXXD2U-L
Rated voltage	vdc	5.00	12.00
Resistance per phase, ± 10%	ohms	14.60	84.00
Inductance per phase, typ	mH	3.80	20.50
Rated current per phase *	amps	0.34	0.14
Maximum force	.001" (0.0254mm) .002" (0.0508mm) .004" (0.1016mm)	oz / N	72 / 20 55 / 15.3 32 / 8.9
Minimum holding force (unenergized)	.001" (0.0254mm) .002" (0.0508mm) .004" (0.1016mm)	oz / N	200 / 55.6 50 / 13.9 20 / 5.5
Maximum travel	.001" (0.0254mm) .002" (0.0508mm) .004" (0.1016mm)	in / mm	1.89 / 48.0 1.89 / 48.0 1.89 / 48.0
Step angle, ± 1° *		degrees	15.00
Steps per revolution *			24
Thermal resistance		°C/watt	N.A.
Ambient temperature range			
Operating		°C	-20 ~ +70
Storage		°C	-40 ~ +85
Bearing type			Ball bearing
Insulation resistance at 500vdc		Mohms	20 megohms
Dielectric withstanding voltage		vac	650 for 2 seconds
Weight		lbs / g	0.075 / 34
Leadwires			AWG 28, UL 1429
Temperature class, max			B (130°C)
RoHS			COMPLIANT

ALL MOTOR DATA VALUES AT 20°C UNLESS OTHERWISE SPECIFIED
* ENERGISE AT RATED CURRENT, 2 PHASE ON, L/R Drive

26DAM-K

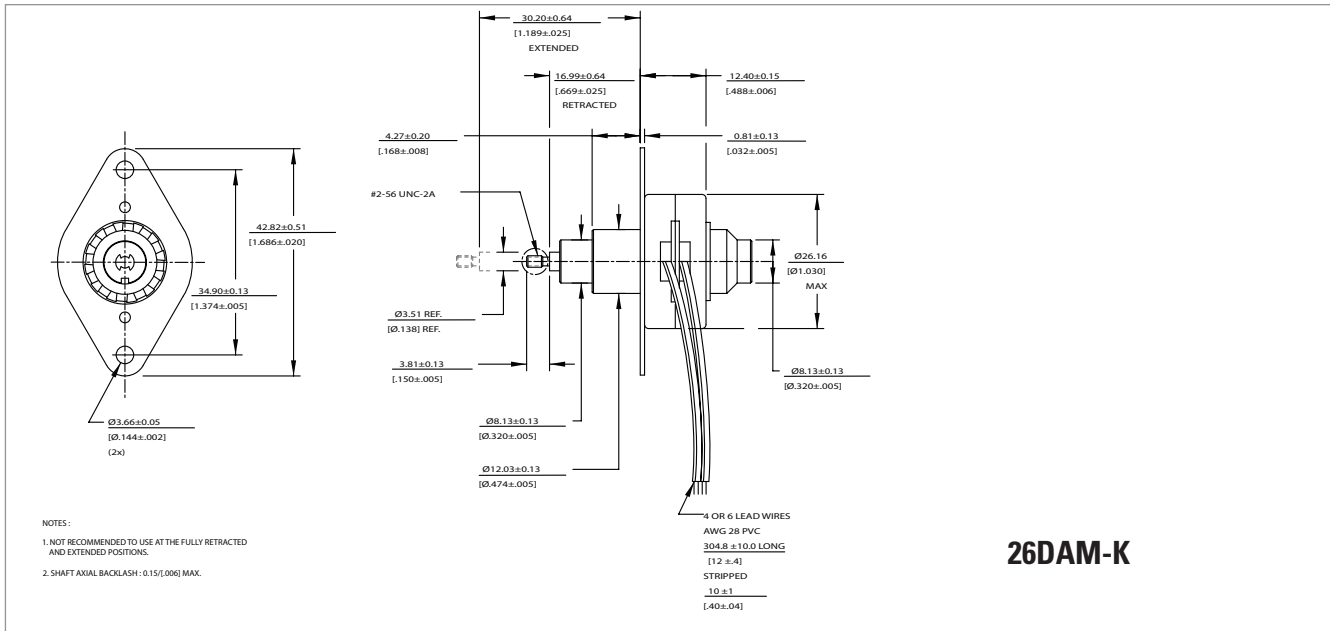

Motor Part Number		26DAMXXD1B-K	26DAMXXD2B-K
Rated voltage	vdc	5.00	12.00
Resistance per phase, ± 10%	ohms	14.60	84.00
Inductance per phase, typ	mH	6.50	33.60
Rated current per phase *	amps	0.34	0.14
Maximum force			
	.001" (0.0254mm)	oz / N	120 / 33.4
	.002" (0.0508mm)		90 / 25
	.004" (0.1016mm)		52 / 14.5
Minimum holding force (unenergized)			
	.001" (0.0254mm)	oz / N	200 / 55.6
	.002" (0.0508mm)		50 / 13.9
	.004" (0.1016mm)		20 / 5.5
Maximum travel			
	.001" (0.0254mm)	in / mm	0.52 / 13.2
	.002" (0.0508mm)		0.52 / 13.2
	.004" (0.1016mm)		0.52 / 13.2
Step angle, ± 1° *	degrees	15.00	
Steps per revolution *		24	
Thermal resistance	°C/watt	N.A.	
Ambient temperature range			
Operating	°C	-20 ~ +70	
Storage	°C	-40 ~ +85	
Bearing type		Ball bearing	
Insulation resistance at 500vdc	Mohms	20 megohms	
Dielectric withstanding voltage	vac	650 for 2 seconds	
Weight	lbs / g	0.075 / 34	
Leadwires		AWG 28, UL 1429	
Temperature class, max		B (130°C)	
RoHS		COMPLIANT	

ALL MOTOR DATA VALUES AT 20°C UNLESS OTHERWISE SPECIFIED
 * ENERGISE AT RATED CURRENT, 2 PHASE ON, L/R Drive

26DAM-K

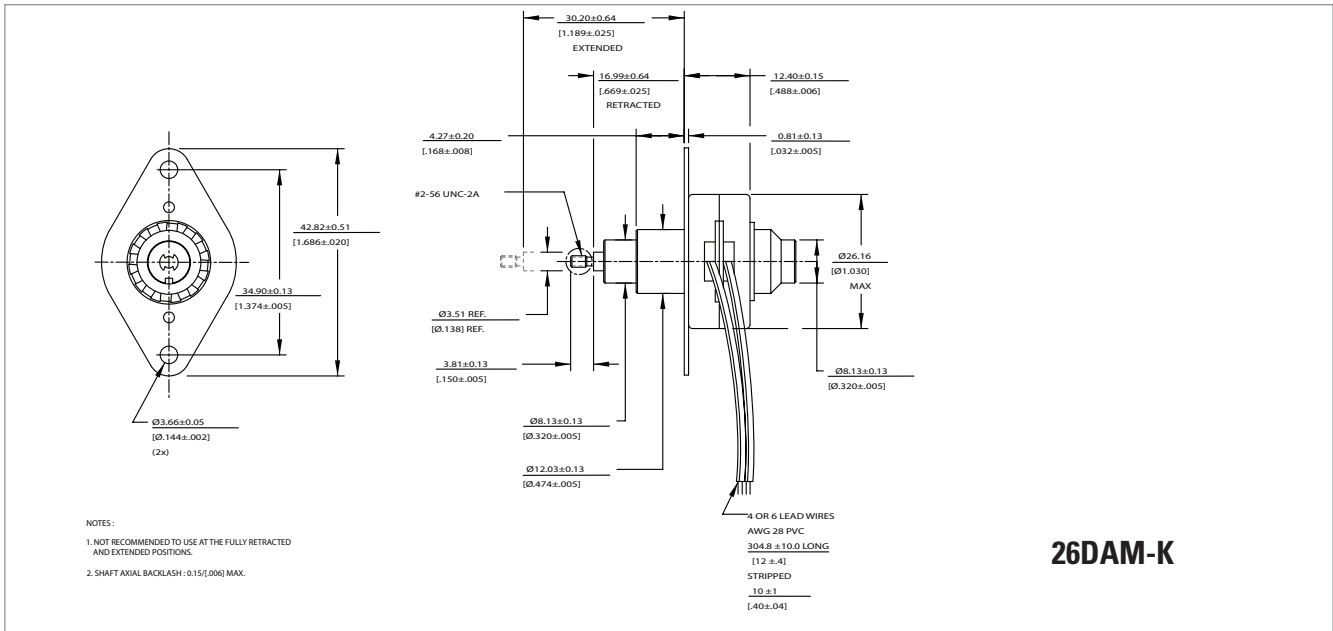

Motor Part Number		26DAMXXD1U-K	26DAMXXD2U-K
Rated voltage	vdc	5.00	12.00
Resistance per phase, ± 10%	ohms	14.60	84.00
Inductance per phase, typ	mH	3.80	20.50
Rated current per phase *	amps	0.34	0.14
Maximum force	.001" (0.0254mm) .002" (0.0508mm) .004" (0.1016mm)	oz / N	72 / 20 55 / 15.3 32 / 8.9
Minimum holding force (unenergized)	.001" (0.0254mm) .002" (0.0508mm) .004" (0.1016mm)	oz / N	200 / 55.6 50 / 13.9 20 / 5.5
Maximum travel	.001" (0.0254mm) .002" (0.0508mm) .004" (0.1016mm)	in / mm	0.52 / 13.2 0.52 / 13.2 0.52 / 13.2
Step angle, ± 1° *	degrees		15.00
Steps per revolution *			24
Thermal resistance	°C/watt		N.A.
Ambient temperature range			
Operating	°C		-20 ~ +70
Storage	°C		-40 ~ +85
Bearing type			Ball bearing
Insulation resistance at 500vdc	Mohms		20 megohms
Dielectric withstanding voltage	vac		650 for 2 seconds
Weight	lbs / g		0.075 / 34
Leadwires			AWG 28, UL 1429
Temperature class, max			B (130°C)
RoHS			COMPLIANT

ALL MOTOR DATA VALUES AT 20°C UNLESS OTHERWISE SPECIFIED
 * ENERGISE AT RATED CURRENT, 2 PHASE ON, L/R Drive

26DBM-L

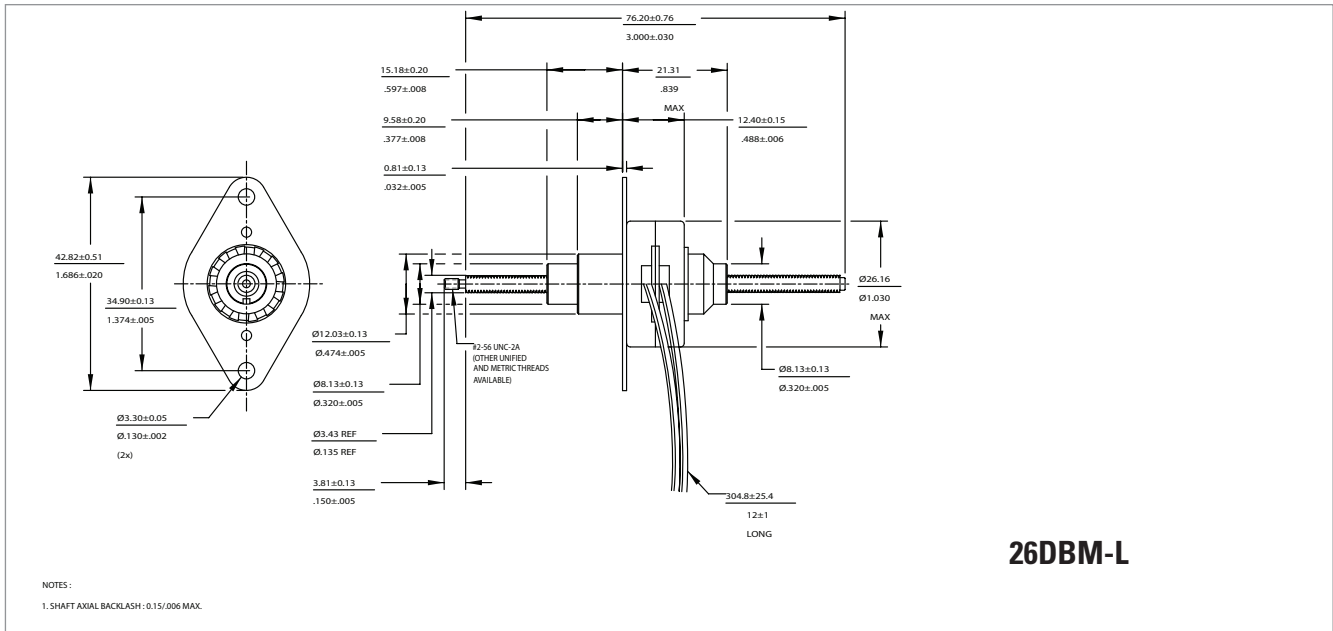

Motor Part Number		26DBMXXD1B-L	26DBMXXD2B-L
Rated voltage	vdc	5.00	12.00
Resistance per phase, ± 10%	ohms	14.60	84.00
Inductance per phase, typ	mH	8.80	46.30
Rated current per phase *	amps	0.34	0.14
Maximum force	.0005" (0.0127mm) .001" (0.0254mm) .002" (0.0508mm)	oz / N	128 / 35.6 104 / 28.9 69 / 19.2
Minimum holding force (unenergized)	.0005" (0.0127mm) .001" (0.0254mm) .002" (0.0508mm)	oz / N	200 / 55.6 50 / 13.9 20 / 5.5
Maximum travel	.0005" (0.0127mm) .001" (0.0254mm) .002" (0.0508mm)	in / mm	1.89 / 48.0 1.89 / 48.0 1.89 / 48.0
Step angle, ± 0.5° *	degrees		7.5
Steps per revolution *			48
Thermal resistance	°C/watt		N.A.
Ambient temperature range			
Operating	°C		-20 ~ +70
Storage	°C		-40 ~ +85
Bearing type			Ball bearing
Insulation resistance at 500vdc	Mohms		20 megohms
Dielectric withstanding voltage	vac		650 for 2 seconds
Weight	lbs / g		0.075 / 34
Leadwires			AWG 28, UL 1429
Temperature class, max			B (130°C)
RoHS			COMPLIANT

ALL MOTOR DATA VALUES AT 20°C UNLESS OTHERWISE SPECIFIED
* ENERGISE AT RATED CURRENT, 2 PHASE ON, L/R Drive

26DBM-L

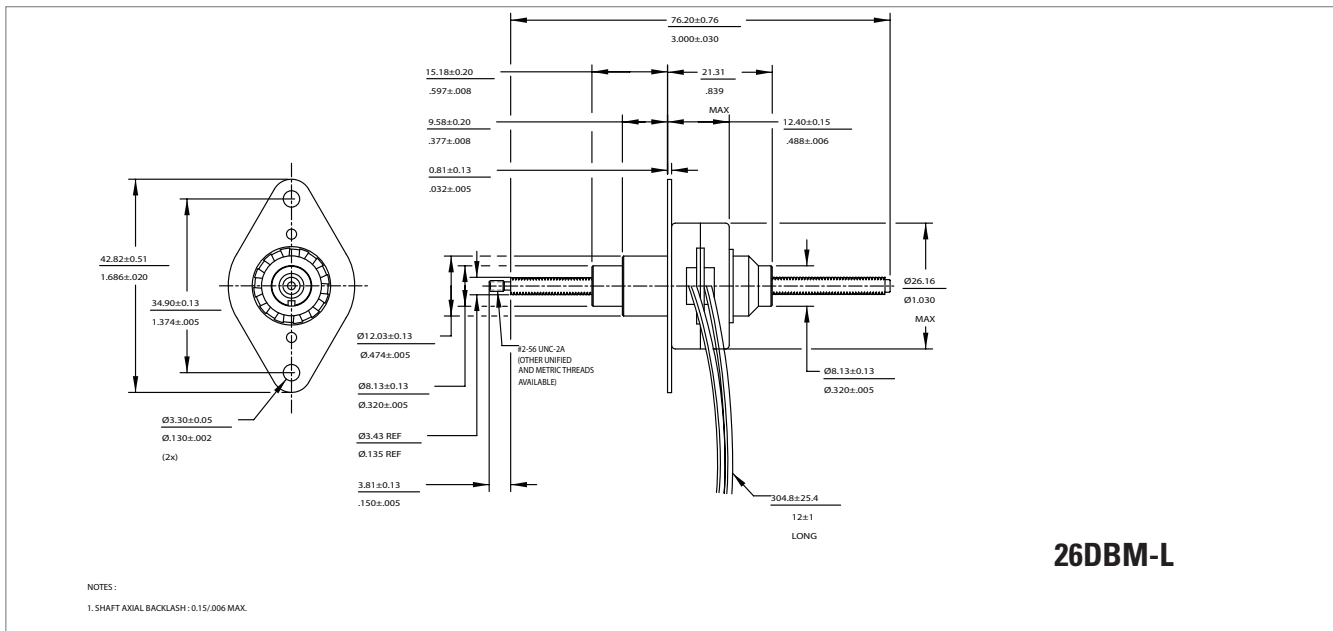

Motor Part Number		26DBMXXD1U-L	26DBMXXD2U-L
Rated voltage	vdc	5.00	12.00
Resistance per phase, ± 10%	ohms	14.60	84.00
Inductance per phase, typ	mH	5.20	27.50
Rated current per phase *	amps	0.34	0.14
Maximum force	.0005" (0.0127mm) .001" (0.0254mm) .002" (0.0508mm)	oz / N	123 / 34.2 101 / 28.1 64 / 17.8
Minimum holding force (unenergized)	.0005" (0.0127mm) .001" (0.0254mm) .002" (0.0508mm)	oz / N	200 / 55.6 50 / 13.9 20 / 5.5
Maximum travel	.0005" (0.0127mm) .001" (0.0254mm) .002" (0.0508mm)	in / mm	1.89 / 48.0 1.89 / 48.0 1.89 / 48.0
Step angle, ± 0.5° *	degrees		7.5
Steps per revolution *			48
Thermal resistance	°C/watt		N.A.
Ambient temperature range			
Operating	°C		-20 ~ +70
Storage	°C		-40 ~ +85
Bearing type			Ball bearing
Insulation resistance at 500vdc	Mohms		20 megohms
Dielectric withstanding voltage	vac		650 for 2 seconds
Weight	lbs / g		0.075 / 34
Leadwires			AWG 28, UL 1429
Temperature class, max			B (130°C)
RoHS			COMPLIANT

ALL MOTOR DATA VALUES AT 20°C UNLESS OTHERWISE SPECIFIED
* ENERGISE AT RATED CURRENT, 2 PHASE ON, L/R Drive

26DBM-K

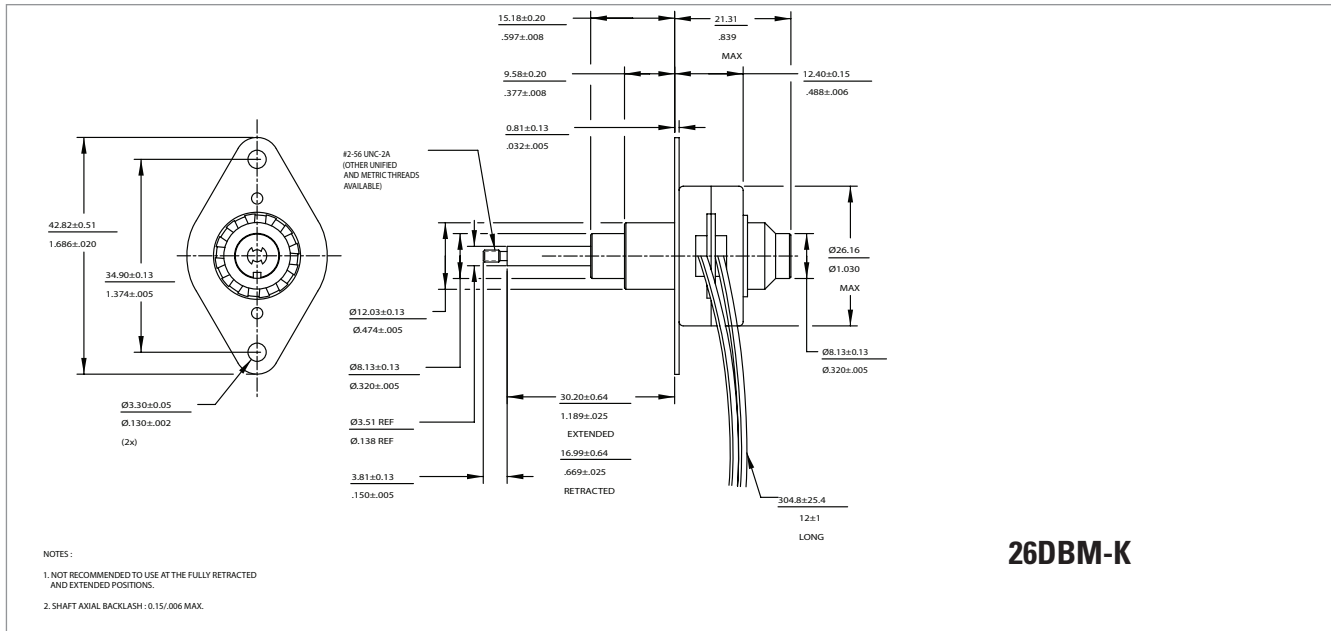

Motor Part Number		26DBMXXD1B-K	26DBMXXD2B-K
Rated voltage	vdc	5.00	12.00
Resistance per phase, ± 10%	ohms	14.60	84.00
Inductance per phase, typ	mH	8.80	46.30
Rated current per phase *	amps	0.34	0.14
Maximum force	.0005" (0.0127mm) .001" (0.0254mm) .002" (0.0508mm)	oz / N	128 / 35.6 104 / 28.9 69 / 19.2
Minimum holding force (unenergized)	.0005" (0.0127mm) .001" (0.0254mm) .002" (0.0508mm)	oz / N	200 / 55.6 50 / 13.9 20 / 5.5
Maximum travel	.0005" (0.0127mm) .001" (0.0254mm) .002" (0.0508mm)	in / mm	0.52 / 13.2 0.52 / 13.2 0.52 / 13.2
Step angle, ± 0.5° *		degrees	7.5
Steps per revolution *			48
Thermal resistance		°C/watt	N.A.
Ambient temperature range			
Operating		°C	-20 ~ +70
Storage		°C	-40 ~ +85
Bearing type			Ball bearing
Insulation resistance at 500vdc		Mohms	20 megohms
Dielectric withstanding voltage		vac	650 for 2 seconds
Weight		lbs / g	0.075 / 34
Leadwires			AWG 28, UL 1429
Temperature class, max			B (130°C)
RoHS			COMPLIANT

ALL MOTOR DATA VALUES AT 20°C UNLESS OTHERWISE SPECIFIED
 * ENERGISE AT RATED CURRENT, 2 PHASE ON, L/R Drive

26DBM-K

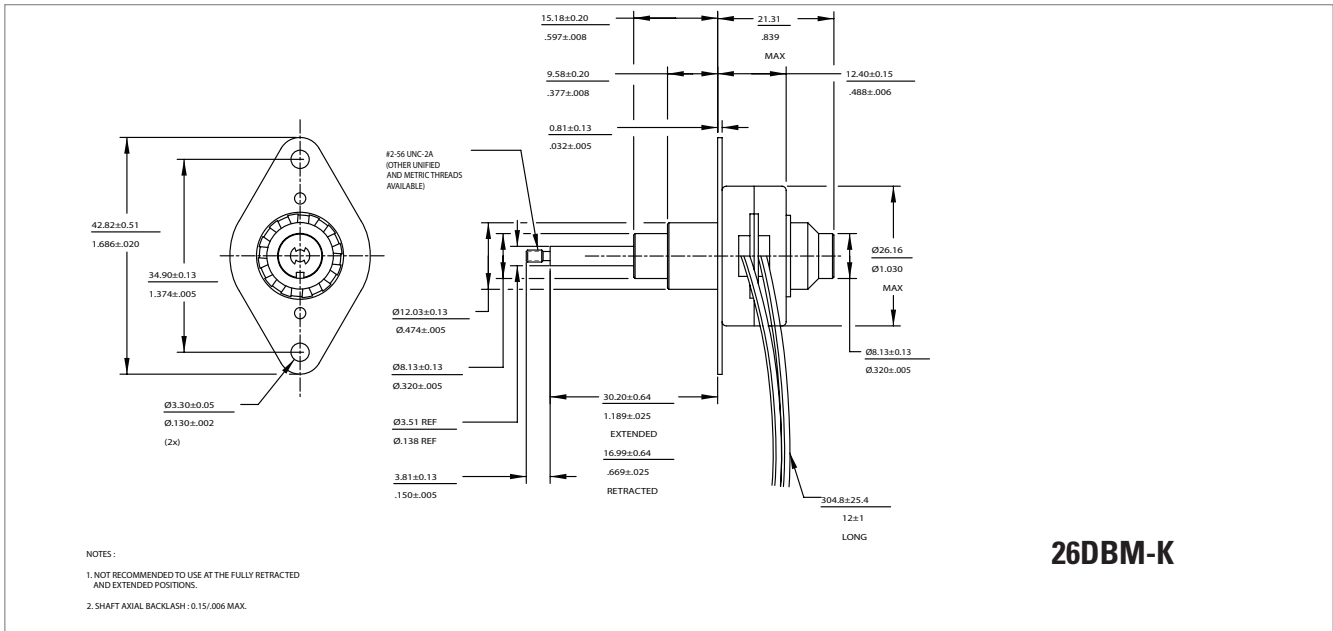

26DBM-K

Motor Part Number		26DBMXXD1U-K	26DBMXXD2U-K
Rated voltage	vdc	5.00	12.00
Resistance per phase, ± 10%	ohms	14.60	84.00
Inductance per phase, typ	mH	5.20	27.50
Rated current per phase *	amps	0.34	0.14
Maximum force	.0005" (0.0127mm) .001" (0.0254mm) .002" (0.0508mm)	oz / N	123 / 34.2 101 / 28.1 64 / 17.8
Minimum holding force (unenergized)	.0005" (0.0127mm) .001" (0.0254mm) .002" (0.0508mm)	oz / N	200 / 55.6 50 / 13.9 20 / 5.5
Maximum travel	.0005" (0.0127mm) .001" (0.0254mm) .002" (0.0508mm)	in / mm	0.52 / 13.2 0.52 / 13.2 0.52 / 13.2
Step angle, ± 0.5° *		degrees	7.5
Steps per revolution *			48
Thermal resistance		°C/watt	N.A.
Ambient temperature range			
Operating		°C	-20 ~ +70
Storage		°C	-40 ~ +85
Bearing type			Ball bearing
Insulation resistance at 500vdc		Mohms	20 megohms
Dielectric withstanding voltage		vac	650 for 2 seconds
Weight		lbs / g	0.075 / 34
Leadwires			AWG 28, UL 1429
Temperature class, max			B (130°C)
RoHS			COMPLIANT

ALL MOTOR DATA VALUES AT 20°C UNLESS OTHERWISE SPECIFIED
* ENERGISE AT RATED CURRENT, 2 PHASE ON, L/R Drive

35DBM-L

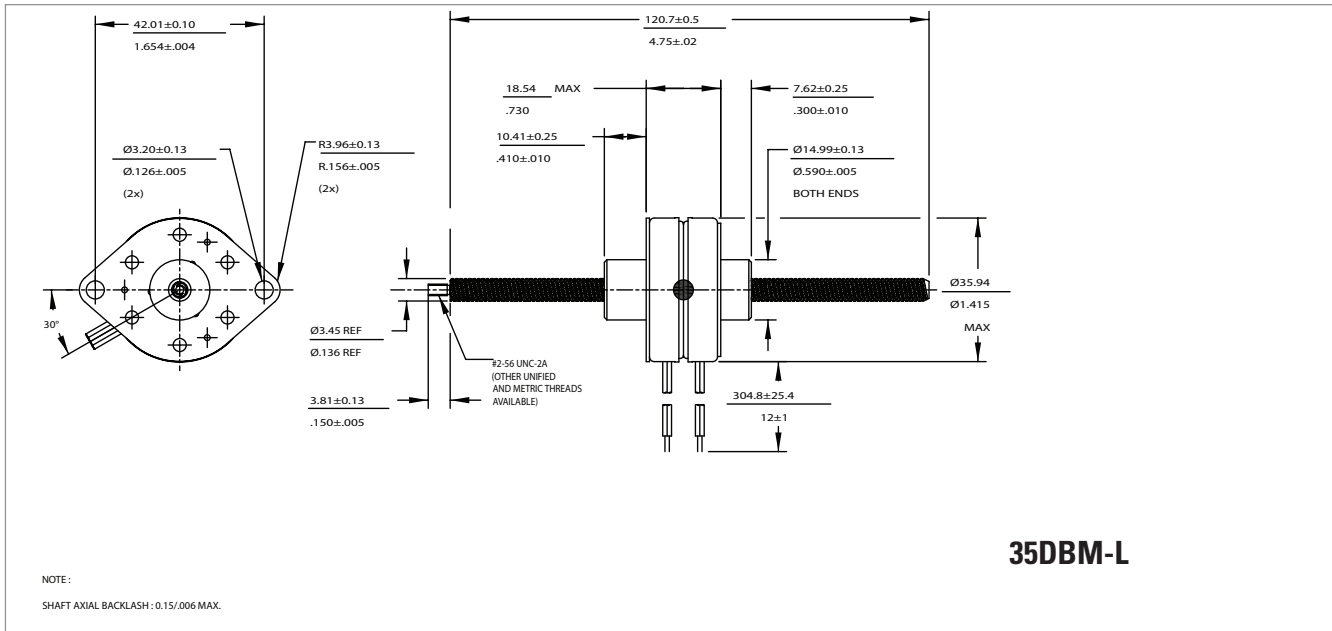

Motor Part Number		35DBMXXB1B-L	35DBMXXB2B-L
Rated voltage	vdc	5.00	12.00
Resistance per phase, ± 10%	ohms	10.00	58.00
Inductance per phase, typ	mH	11.20	60.00
Rated current per phase *	amps	0.50	0.21
Maximum force			
	.001" (0.0254mm)	oz / N	103.9 / 28.9
	.002" (0.0508mm)		84.9 / 23.6
	.003" (0.0762mm)		47.8 / 13.3
Minimum holding force (unenergized)			
	.001" (0.0254mm)	oz / N	40 / 11.1
	.002" (0.0508mm)		10 / 2.8
	.003" (0.0762mm)		5 / 1.4
Maximum travel			
	.001" (0.0254mm)	in / mm	2.5 / 63.5
	.002" (0.0508mm)		2.5 / 63.5
	.003" (0.0762mm)		2.5 / 63.5
Step angle, ± 0.5° *	degrees		7.5
Steps per revolution *			48
Thermal resistance	°C/watt		N.A.
Ambient temperature range			
Operating	°C		-20 ~ +70
Storage	°C		-40 ~ +85
Bearing type			Ball bearing
Insulation resistance at 500vdc	Mohms		20 megohms
Dielectric withstanding voltage	vac		650 for 2 seconds
Weight	lbs / g		0.1875 / 85.2
Leadwires			AWG 26, UL 1429
Temperature class, max			B (130°C)
RoHS			COMPLIANT

ALL MOTOR DATA VALUES AT 20°C UNLESS OTHERWISE SPECIFIED
* ENERGISE AT RATED CURRENT, 2 PHASE ON, L/R Drive

35DBM-L

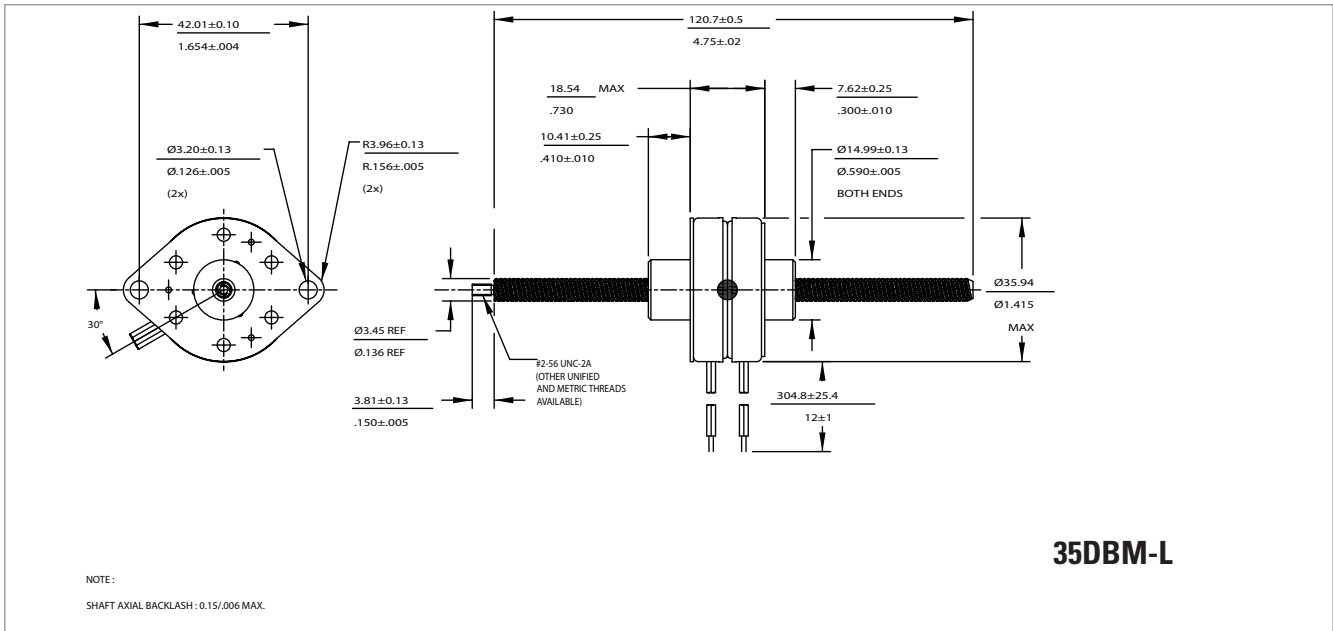

35DBM-L

Motor Part Number		35DBMXXB1U-L	35DBMXXB2U-L
Rated voltage	vdc	5.00	12.00
Resistance per phase, ± 10%	ohms	10.00	58.00
Inductance per phase, typ	mH	5.20	30.00
Rated current per phase *	amps	0.50	0.21
Maximum force			
	.001" (0.0254mm)	oz / N	75 / 20.9
	.002" (0.0508mm)		55 / 15.3
	.003" (0.0762mm)		30 / 8.3
Minimum holding force (unenergized)			
	.001" (0.0254mm)	oz / N	40 / 11.1
	.002" (0.0508mm)		10 / 2.8
	.003" (0.0762mm)		5 / 1.4
Maximum travel			
	.001" (0.0254mm)	in / mm	2.5 / 63.5
	.002" (0.0508mm)		2.5 / 63.5
	.003" (0.0762mm)		2.5 / 63.5
Step angle, ± 0.5° *	degrees		7.5
Steps per revolution *			48
Thermal resistance	°C/watt		N.A.
Ambient temperature range			
Operating	°C		-20 ~ +70
Storage	°C		-40 ~ +85
Bearing type			Ball bearing
Insulation resistance at 500vdc	Mohms		20 megohms
Dielectric withstanding voltage	vac		650 for 2 seconds
Weight	lbs / g		0.1875 / 85.2
Leadwires			AWG 26, UL 1429
Temperature class, max			B (130°C)
RoHS			COMPLIANT

ALL MOTOR DATA VALUES AT 20°C UNLESS OTHERWISE SPECIFIED
* ENERGISE AT RATED CURRENT, 2 PHASE ON, L/R Drive

35DBM-K

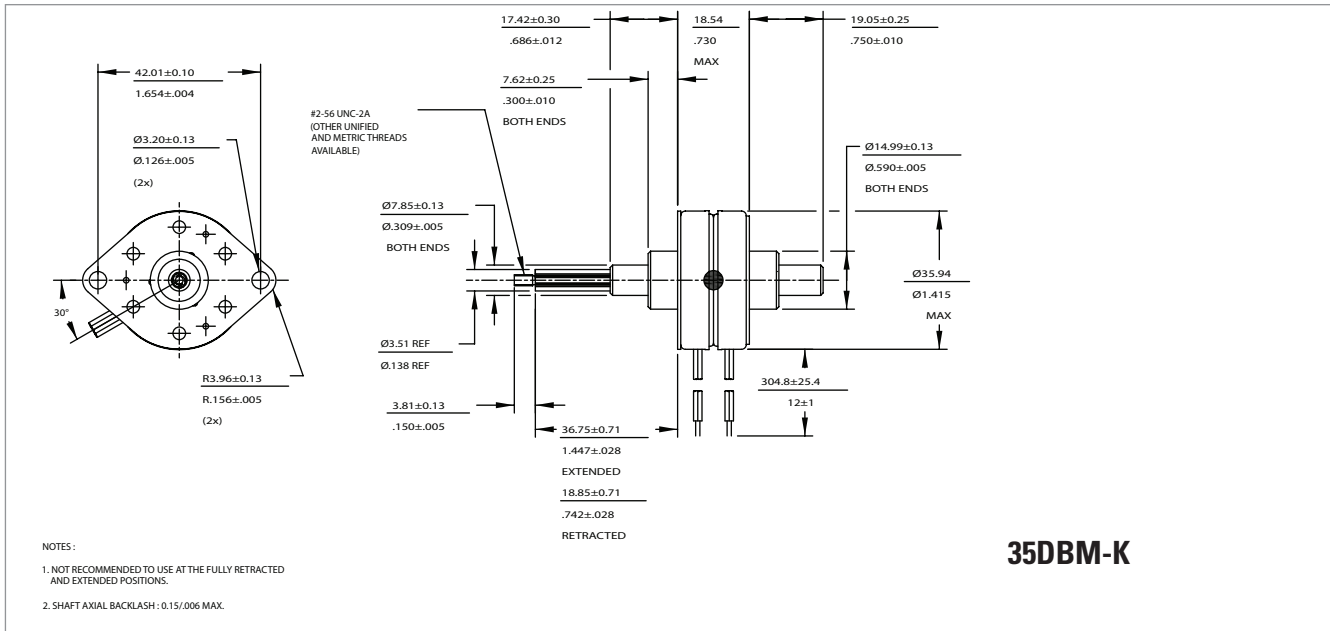

35DBM-K

Motor Part Number		35DBMXXB1B-K	35DBMXXB2B-K
Rated voltage	vdc	5.00	12.00
Resistance per phase, ± 10%	ohms	10.00	58.00
Inductance per phase, typ	mH	11.20	60.00
Rated current per phase *	amps	0.50	0.21
Maximum force	.001" (0.0254mm) .002" (0.0508mm) .003" (0.0762mm)	oz / N	103.9 / 28.9 84.9 / 23.6 47.8 / 13.3
Minimum holding force (unenergized)	.001" (0.0254mm) .002" (0.0508mm) .003" (0.0762mm)	oz / N	40 / 11.1 10 / 2.8 5 / 1.4
Maximum travel	.001" (0.0254mm) .002" (0.0508mm) .003" (0.0762mm)	in / mm	0.705 / 17.9 0.705 / 17.9 0.705 / 17.9
Step angle, ± 0.5° *		degrees	7.5
Steps per revolution *			48
Thermal resistance		°C/watt	N.A.
Ambient temperature range			
Operating		°C	-20 ~ +70
Storage		°C	-40 ~ +85
Bearing type			Ball bearing
Insulation resistance at 500vdc		Mohms	20 megohms
Dielectric withstanding voltage		vac	650 for 2 seconds
Weight		lbs / g	0.1875 / 85.2
Leadwires			AWG 26, UL 1429
Temperature class, max			B (130°C)
RoHS			COMPLIANT

ALL MOTOR DATA VALUES AT 20°C UNLESS OTHERWISE SPECIFIED
* ENERGISE AT RATED CURRENT, 2 PHASE ON, L/R Drive

35DBM-K

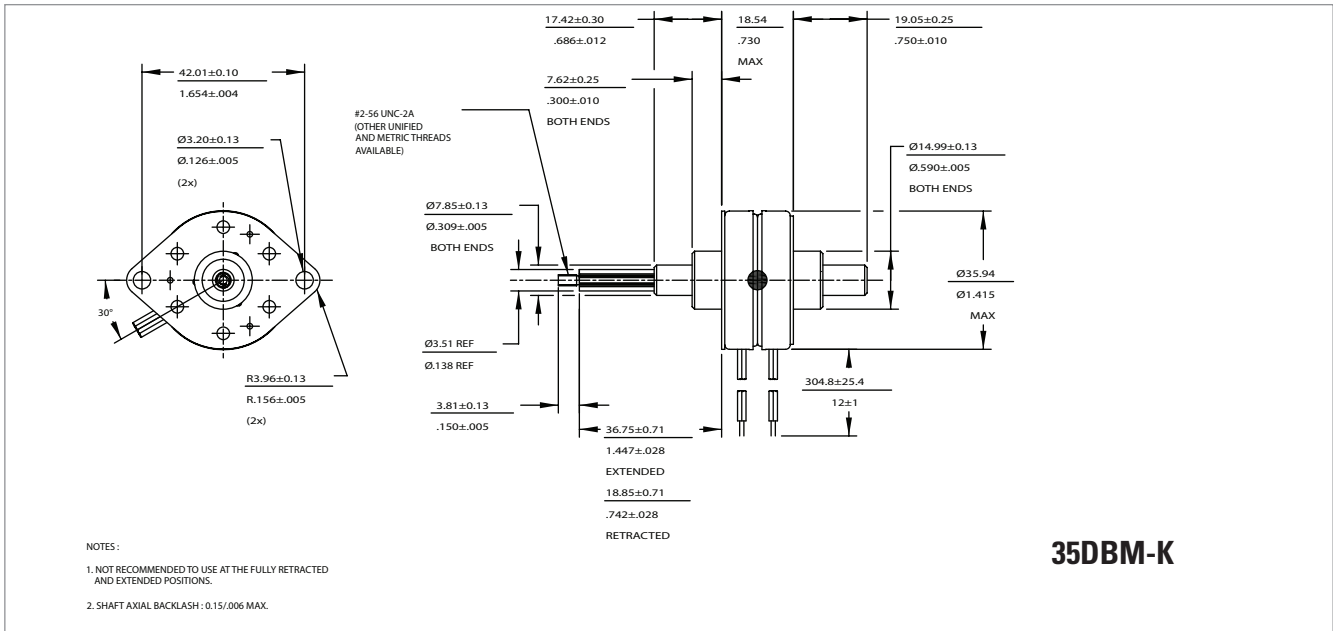

35DBM-K

Motor Part Number		35DBMXXB1U-K	35DBMXXB2U-K
Rated voltage	vdc	5.00	12.00
Resistance per phase, ± 10%	ohms	10.00	58.00
Inductance per phase, typ	mH	5.20	30.00
Rated current per phase *	amps	0.50	0.21
Maximum force	.001" (0.0254mm) .002" (0.0508mm) .003" (0.0762mm)	oz / N	75 / 20.9 55 / 15.3 30 / 8.3
Minimum holding force (unenergized)	.001" (0.0254mm) .002" (0.0508mm) .003" (0.0762mm)	oz / N	40 / 11.1 10 / 2.8 5 / 1.4
Maximum travel	.001" (0.0254mm) .002" (0.0508mm) .003" (0.0762mm)	in / mm	0.705 / 17.9 0.705 / 17.9 0.705 / 17.9
Step angle, ± 0.5° *	degrees		7.5
Steps per revolution *			48
Thermal resistance	°C/watt		N.A.
Ambient temperature range			
Operating	°C		-20 ~ +70
Storage	°C		-40 ~ +85
Bearing type			Ball bearing
Insulation resistance at 500vdc	Mohms		20 megohms
Dielectric withstanding voltage	vac		650 for 2 seconds
Weight	lbs / g		0.1875 / 85.2
Leadwires			AWG 26, UL 1429
Temperature class, max			B (130°C)
RoHS			COMPLIANT

ALL MOTOR DATA VALUES AT 20°C UNLESS OTHERWISE SPECIFIED
* ENERGISE AT RATED CURRENT, 2 PHASE ON, L/R Drive

42DBL-L

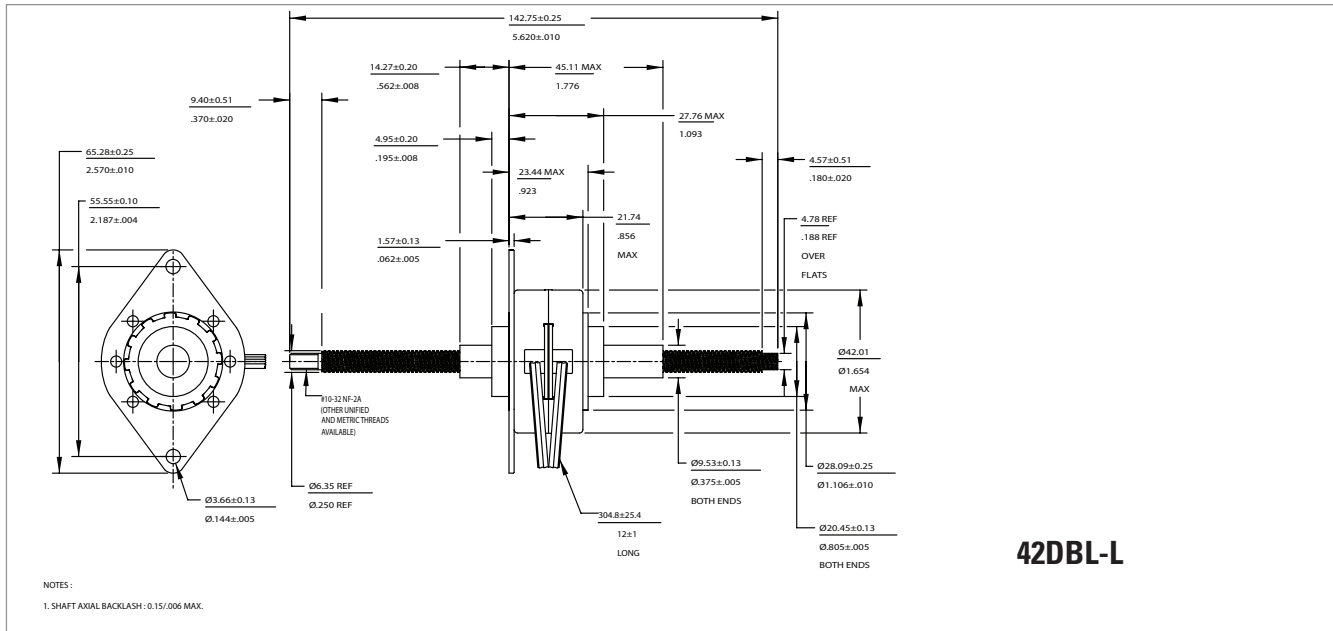

Motor Part Number		42DBLXC1B-L	42DBLXC2B-L
Rated voltage	vdc	5.00	12.00
Resistance per phase, ± 10%	ohms	5.00	28.80
Inductance per phase, typ	mH	5.50	39.30
Rated current per phase *	amps	1.00	0.42
Maximum force	.001" (0.0254mm) .002" (0.0508mm) .004" (0.1016mm)	oz / N	370 / 102.9 300 / 83.4 200 / 55.6
Minimum holding force (unenergized)	.001" (0.0254mm) .002" (0.0508mm) .004" (0.1016mm)	oz / N	400 / 111.2 300 / 83.4 70 / 19.5
Maximum travel	.001" (0.0254mm) .002" (0.0508mm) .004" (0.1016mm)	in / mm	2.4 / 61.0 2.4 / 61.0 2.4 / 61.0
Step angle, ± 0.5° *		degrees	7.5
Steps per revolution *			48
Thermal resistance		°C/watt	N.A.
Ambient temperature range			
Operating		°C	-20 ~ +70
Storage		°C	-40 ~ +85
Bearing type			Ball bearing
Insulation resistance at 500vdc		Mohms	20 megohms
Dielectric withstanding voltage		vac	650 for 2 seconds
Weight		lbs / g	0.344 / 156
Leadwires			AWG 26, UL 1430
Temperature class, max			B (130°C)
RoHS			COMPLIANT

ALL MOTOR DATA VALUES AT 20°C UNLESS OTHERWISE SPECIFIED
* ENERGISE AT RATED CURRENT, 2 PHASE ON, L/R Drive

42DBL-L

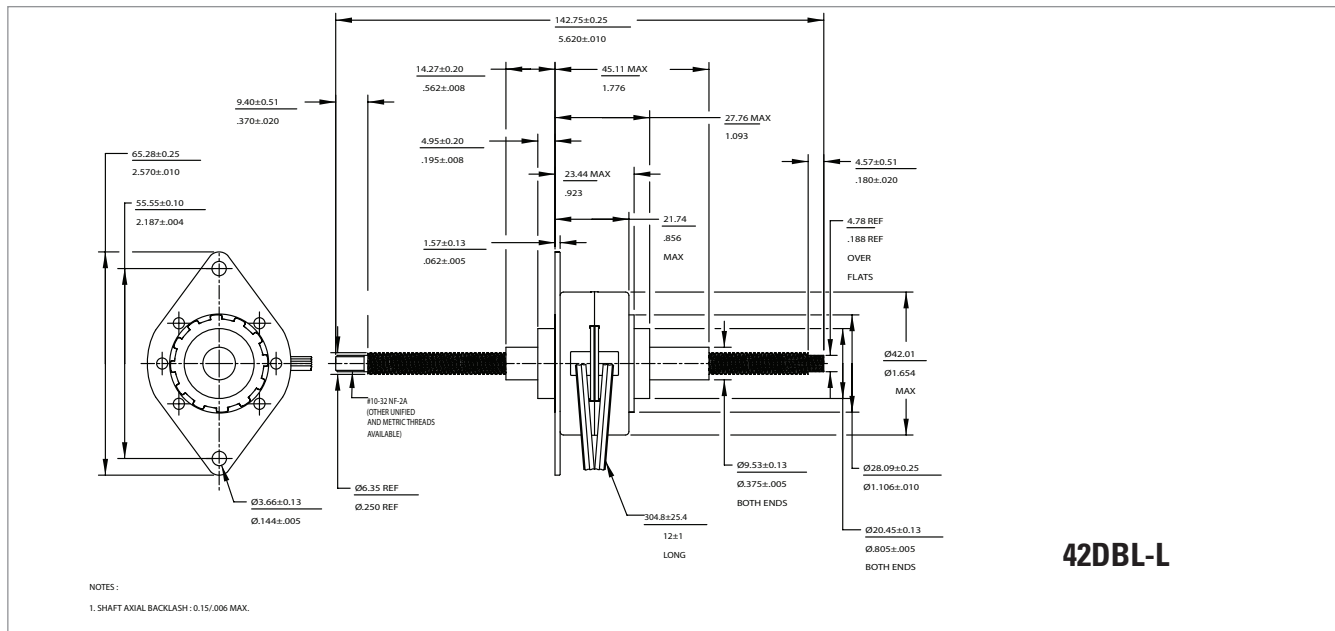

42DBL-L

Motor Part Number		42DBLXXC1U-L	42DBLXXC2U-L
Rated voltage	vdc	5.00	12.00
Resistance per phase, ± 10%	ohms	5.00	28.80
Inductance per phase, typ	mH	3.70	15.00
Rated current per phase *	amps	1.00	0.42
Maximum force	.001" (0.0254mm) .002" (0.0508mm) .004" (0.1016mm)	oz / N	360 / 100 260 / 72.3 180 / 50
Minimum holding force (unenergized)	.001" (0.0254mm) .002" (0.0508mm) .004" (0.1016mm)	oz / N	400 / 111.2 300 / 83.4 70 / 19.5
Maximum travel	.001" (0.0254mm) .002" (0.0508mm) .004" (0.1016mm)	in / mm	2.4 / 61.0 2.4 / 61.0 2.4 / 61.0
Step angle, ± 0.5° *		degrees	7.5
Steps per revolution *			48
Thermal resistance		°C/watt	N.A.
Ambient temperature range			
Operating		°C	-20 ~ +70
Storage		°C	-40 ~ +85
Bearing type			Ball bearing
Insulation resistance at 500vdc		Mohms	20 megohms
Dielectric withstanding voltage		vac	650 for 2 seconds
Weight		lbs / g	0.344 / 156
Leadwires			AWG 26, UL 1430
Temperature class, max			B (130°C)
RoHS			COMPLIANT

Stepper

ALL MOTOR DATA VALUES AT 20°C UNLESS OTHERWISE SPECIFIED
* ENERGISE AT RATED CURRENT, 2 PHASE ON. L/R Drive

42DBL-K

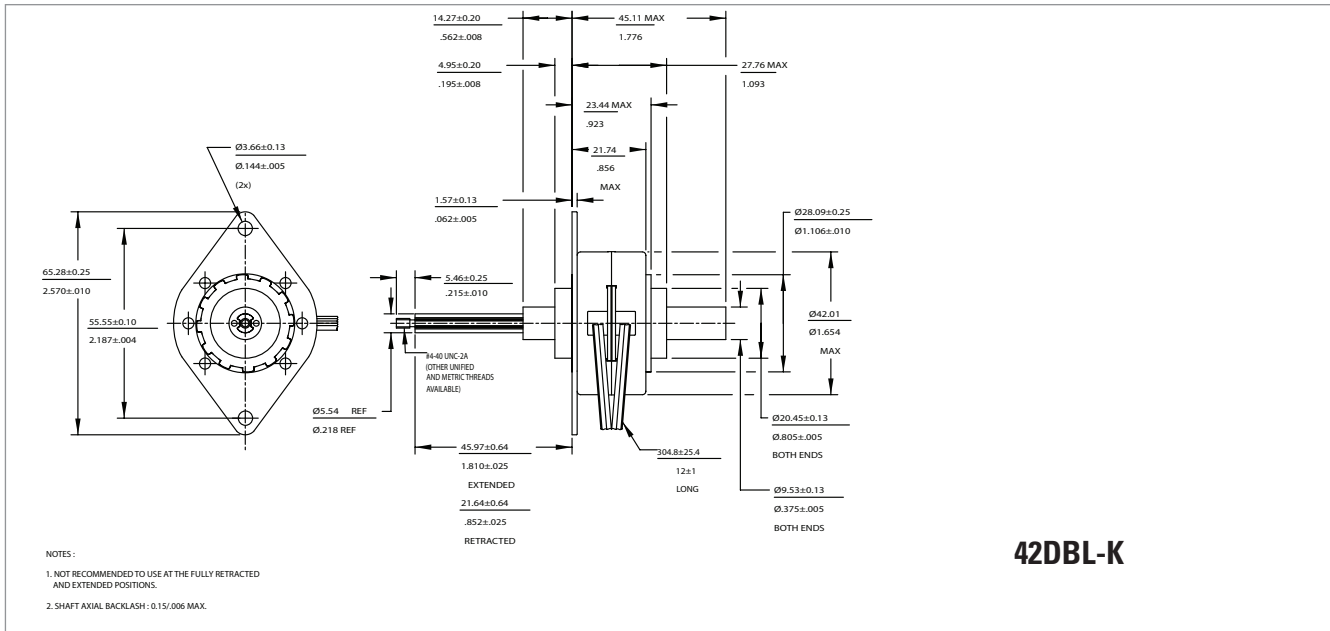

42DBL-K

Motor Part Number		42DBLXC1B-K	42DBLXC2B-K
Rated voltage	vdc	5.00	12.00
Resistance per phase, ± 10%	ohms	5.00	28.80
Inductance per phase, typ	mH	5.50	39.30
Rated current per phase *	amps	1.00	0.42
Maximum force	.001" (0.0254mm) .002" (0.0508mm) .004" (0.1016mm)	oz / N	370 / 102.9 300 / 83.4 200 / 55.6
Minimum holding force (unenergized)	.001" (0.0254mm) .002" (0.0508mm) .004" (0.1016mm)	oz / N	400 / 111.2 300 / 83.4 70 / 19.5
Maximum travel	.001" (0.0254mm) .002" (0.0508mm) .004" (0.1016mm)	in / mm	0.95 / 24.1 0.95 / 24.1 0.95 / 24.1
Step angle, ± 0.5° *		degrees	7.5
Steps per revolution *			48
Thermal resistance		°C/watt	N.A.
Ambient temperature range			
Operating		°C	-20 ~ +70
Storage		°C	-40 ~ +85
Bearing type			Ball bearing
Insulation resistance at 500vdc		Mohms	20 megohms
Dielectric withstanding voltage		vac	650 for 2 seconds
Weight		lbs / g	0.344 / 156
Leadwires			AWG 26, UL 1430
Temperature class, max			B (130°C)
RoHS			COMPLIANT

ALL MOTOR DATA VALUES AT 20°C UNLESS OTHERWISE SPECIFIED
* ENERGISE AT RATED CURRENT, 2 PHASE ON, L/R Drive

42DBL-K

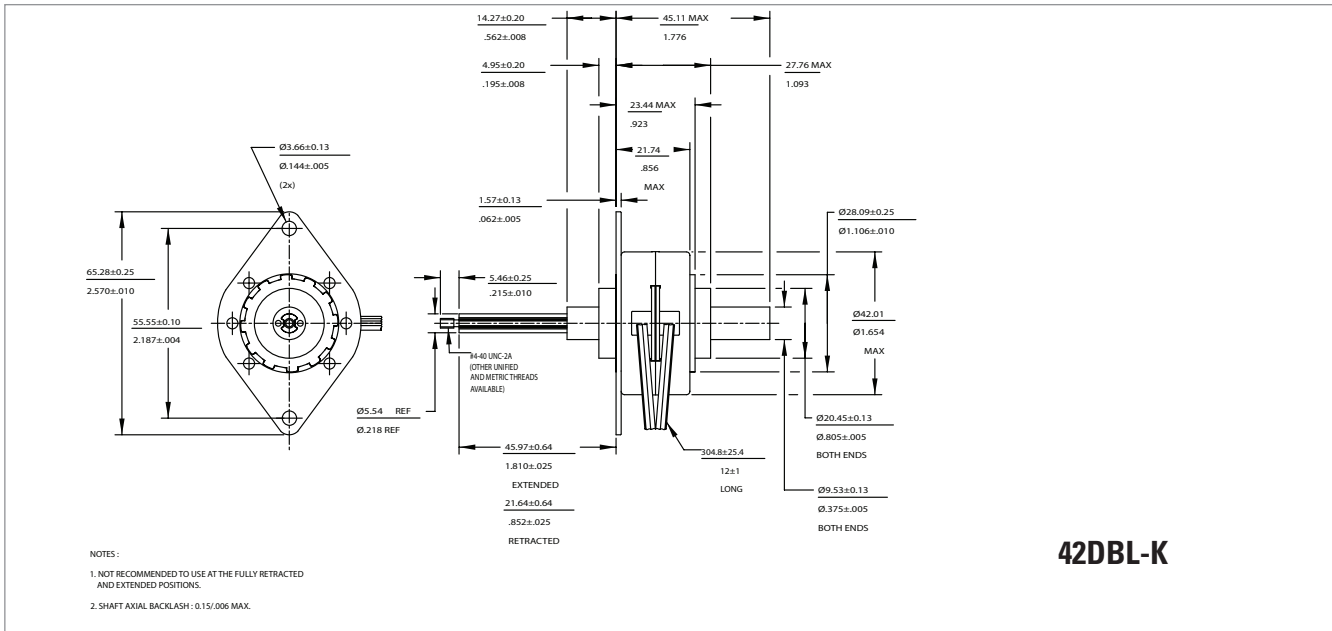

42DBL-K

Motor Part Number		42DBLXC1U-K	42DBLXC2U-K
Rated voltage	vdc	5.00	12.00
Resistance per phase, ± 10%	ohms	5.00	28.80
Inductance per phase, typ	mH	3.70	15.00
Rated current per phase *	amps	1.00	0.42
Maximum force	.001" (0.0254mm) .002" (0.0508mm) .004" (0.1016mm)	oz / N	360 / 100 260 / 72.3 180 / 50
Minimum holding force (unenergized)	.001" (0.0254mm) .002" (0.0508mm) .004" (0.1016mm)	oz / N	400 / 111.2 300 / 83.4 70 / 19.5
Maximum travel	.001" (0.0254mm) .002" (0.0508mm) .004" (0.1016mm)	in / mm	0.95 / 24.1 0.95 / 24.1 0.95 / 24.1
Step angle, ± 0.5° *		degrees	7.5
Steps per revolution *			48
Thermal resistance		°C/watt	N.A.
Ambient temperature range			
Operating		°C	-20 ~ +70
Storage		°C	-40 ~ +85
Bearing type			Ball bearing
Insulation resistance at 500vdc		Mohms	20 megohms
Dielectric withstanding voltage		vac	650 for 2 seconds
Weight		lbs / g	0.344 / 156
Leadwires			AWG 26, UL 1430
Temperature class, max			B (130°C)
RoHS			COMPLIANT

ALL MOTOR DATA VALUES AT 20°C UNLESS OTHERWISE SPECIFIED
 * ENERGISE AT RATED CURRENT, 2 PHASE ON, L/R Drive

57DBM-L

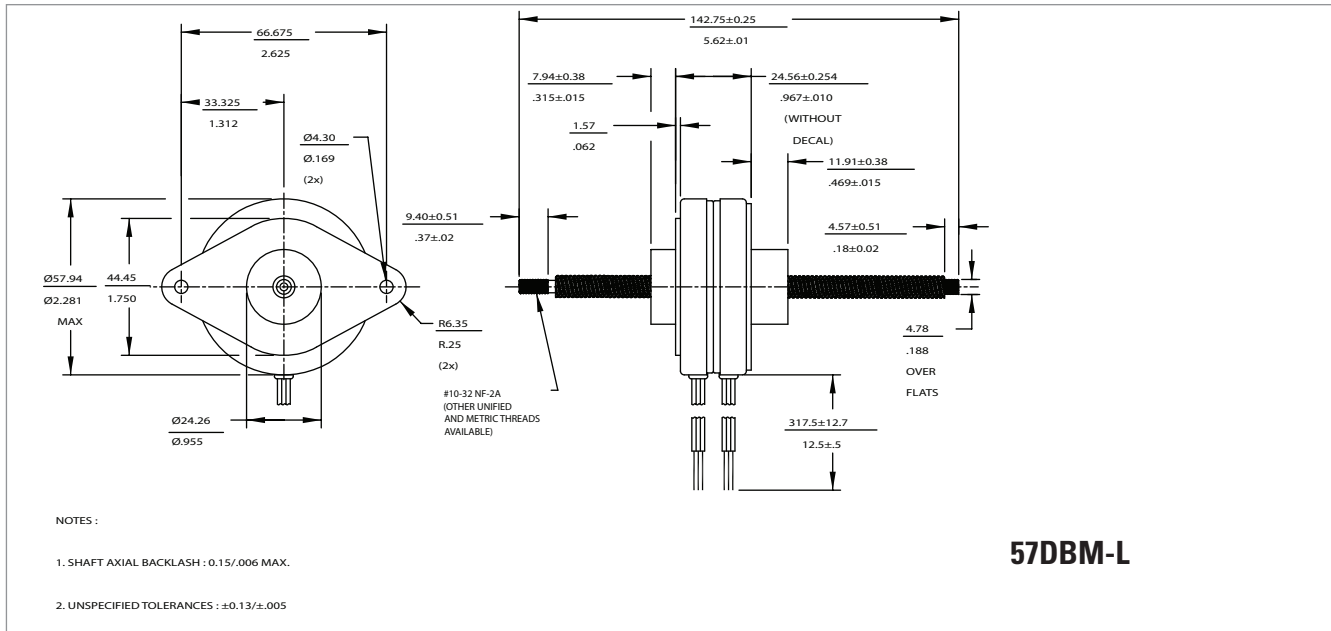

Motor Part Number		57DBMXXB1B-L	57DBMXXB2B-L
Rated voltage	vdc	5.00	12.00
Resistance per phase, ± 10%	ohms	4.30	25.00
Inductance per phase, typ	mH	6.30	36.00
Rated current per phase *	amps	1.16	0.48
Maximum force	.001" (0.0254mm) .002" (0.0508mm)	oz / N	448 / 124.6 368 / 102.4
Minimum holding force (unenergized)	.001" (0.0254mm) .002" (0.0508mm)	oz / N	>320 / 88 >256 / 71
Maximum travel	.001" (0.0254mm) .002" (0.0508mm)	in / mm	3 / 76.2 3 / 76.2
Step angle, ± 0.5° *		degrees	7.5
Steps per revolution *			48
Thermal resistance		°C/watt	N.A.
Ambient temperature range			
Operating		°C	-20 ~ +70
Storage		°C	-40 ~ +85
Bearing type			Ball bearing
Insulation resistance at 500vdc		Mohms	20 megohms
Dielectric withstanding voltage		vac	650 for 5 seconds
Weight		lbs / g	1 / 454
Leadwires			AWG 26, MIL
Temperature class, max			B (130°C)
RoHS			COMPLIANT

ALL MOTOR DATA VALUES AT 20°C UNLESS OTHERWISE SPECIFIED
 * ENERGISE AT RATED CURRENT, 2 PHASE ON, L/R Drive

57DBM-L

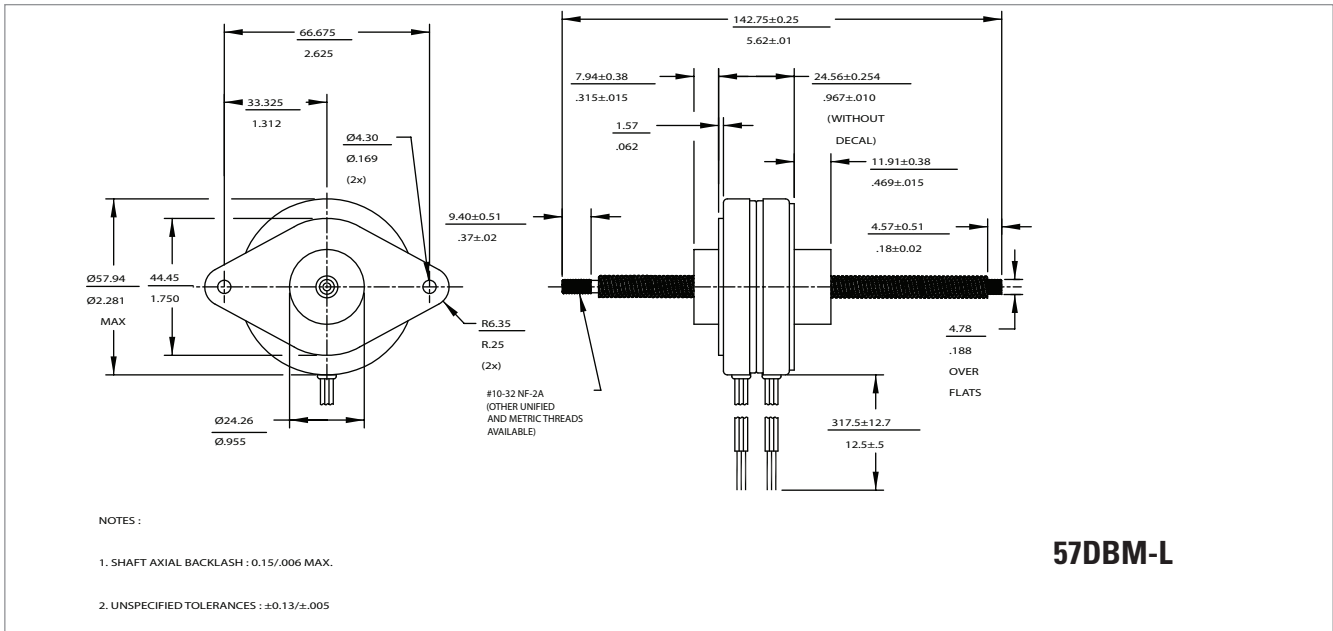

Motor Part Number		57DBMXXB1U-L	57DBMXXB2U-L
Rated voltage	vdc	5.00	12.00
Resistance per phase, ± 10%	ohms	4.30	25.00
Inductance per phase, typ	mH	5.00	25.00
Rated current per phase *	amps	1.16	0.48
Maximum force	.001" (0.0254mm) .002" (0.0508mm)	oz / N	320 / 88 256 / 71
Minimum holding force (unenergized)	.001" (0.0254mm) .002" (0.0508mm)	oz / N	>320 / 88 >256 / 71
Maximum travel	.001" (0.0254mm) .002" (0.0508mm)	in / mm	3 / 76.2 3 / 76.2
Step angle, ± 0.5° *		degrees	7.5
Steps per revolution *			48
Thermal resistance		°C/watt	N.A.
Ambient temperature range			
Operating		°C	-20 ~ +70
Storage		°C	-40 ~ +85
Bearing type			Ball bearing
Insulation resistance at 500vdc		Mohms	20 megohms
Dielectric withstanding voltage		vac	650 for 2 seconds
Weight		lbs / g	1 / 454
Leadwires			AWG 26, MIL
Temperature class, max			B (130°C)
RoHS			COMPLIANT

ALL MOTOR DATA VALUES AT 20°C UNLESS OTHERWISE SPECIFIED
 * ENERGISE AT RATED CURRENT, 2 PHASE ON, L/R Drive

20DAMXXDXU-K/L
 Typical pull-in linear force vs linear rate at 20°C
 Full step, Unipolar, L/R drive

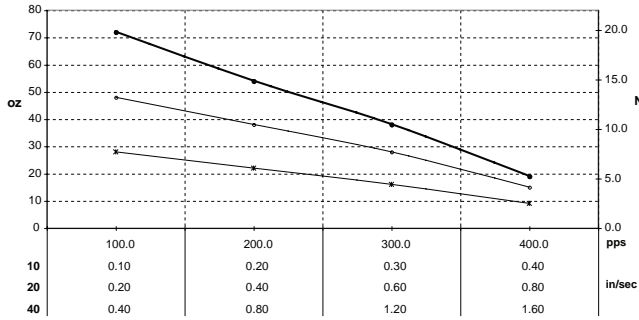

● 20DAM10DXU-K/L Pull-In Force
 ○ 20DAM20DXU-K/L Pull-In Force
 * 20DAM40DXU-K/L Pull-In Force

20DAMXXDXB-K/L
 Typical pull-in linear force vs linear rate at 20°C
 Full step, Bipolar, L/R drive

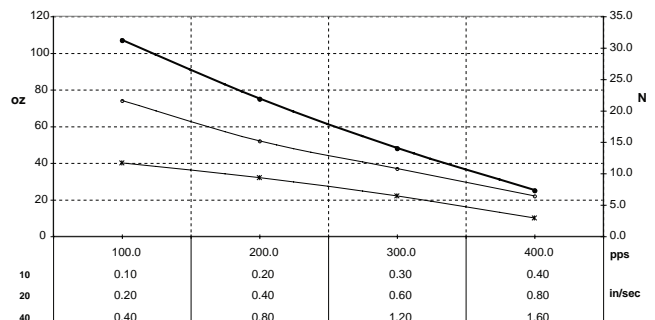

● 20DAM10DXB-K/L Pull-In Force
 ○ 20DAM20DXB-K/L Pull-In Force
 * 20DAM40DXB-K/L Pull-In Force

26DAMXXDXU-K/L
 Typical pull-in linear force vs linear rate at 20°C
 Full step, Unipolar, L/R drive

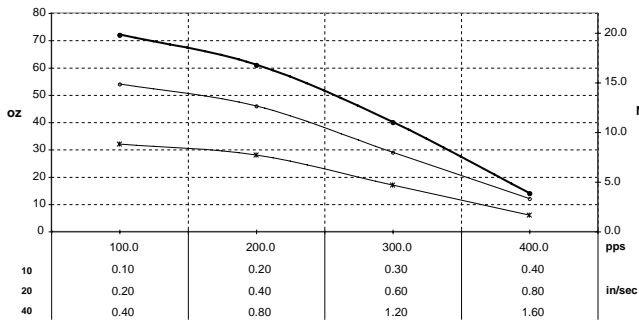

● 26DAM10DXU-K/L Pull-In Force
 ○ 26DAM20DXU-K/L Pull-In Force
 * 26DAM40DXU-K/L Pull-In Force

26DAMXXDXB-K/L
 Typical pull-in linear force vs linear rate at 20°C
 Full step, Bipolar, L/R drive

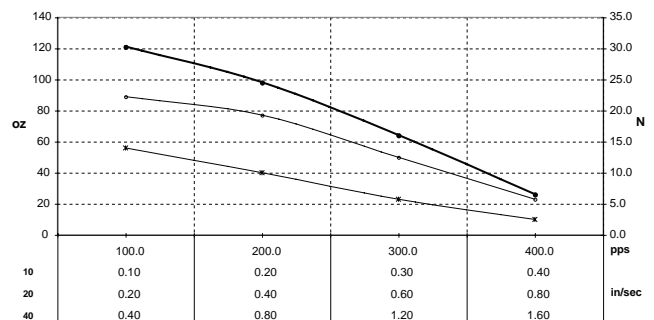

● 26DAM10DXB-K/L Pull-In Force
 ○ 26DAM20DXB-K/L Pull-In Force
 * 26DAM40DXB-K/L Pull-In Force

26DBMXXDXU-K/L
 Typical pull-in linear force vs linear rate at 20°C
 Full step, Unipolar, L/R drive

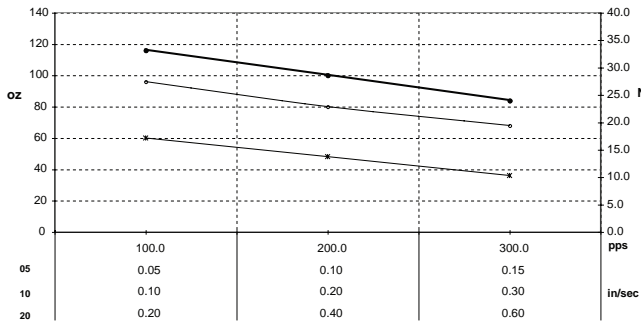

● 26DBM05DXU-K/L Pull-In Force
 ○ 26DBM10DXU-K/L Pull-In Force
 * 26DBM20DXU-K/L Pull-In Force

26DBMXXDXB-K/L
 Typical pull-in linear force vs linear rate at 20°C
 Full step, Bipolar, L/R drive

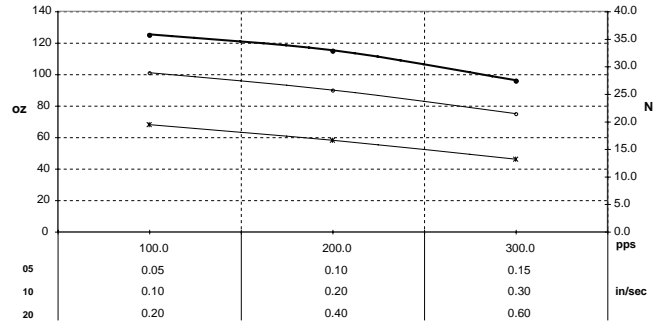

● 26DBM05DXB-K/L Pull-In Force
 ○ 26DBM10DXB-K/L Pull-In Force
 * 26DBM20DXB-K/L Pull-In Force

35DBMXXBXU-K/L
 Typical pull-in linear force vs linear rate at 20°C
 Full step, Unipolar, L/R drive

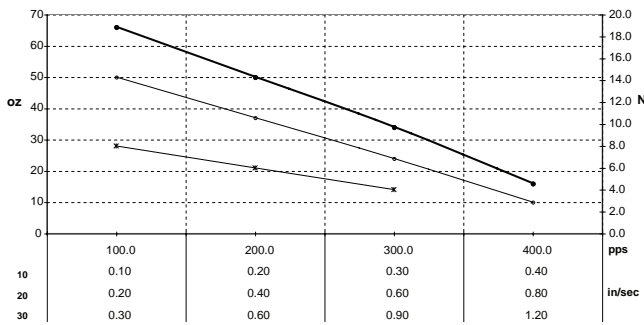

● 35DBM10BXU-K/L Pull-In Force
 ○ 35DBM20BXU-K/L Pull-In Force
 * 35DBM30BXU-K/L Pull-In Force

35DBMXXBxB-K/L
 Typical pull-in linear force vs linear rate at 20°C
 Full step, Bipolar, L/R drive

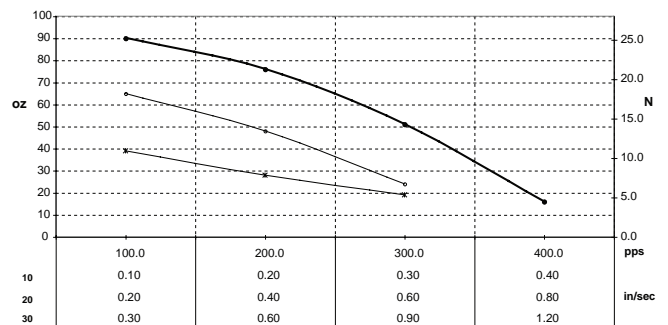

● 35DBM10BxB-K/L Pull-In Force
 ○ 35DBM20BxB-K/L Pull-In Force
 * 35DBM30BxB-K/L Pull-In Force

42DBLXXCXU-K/L
 Typical pull-in linear force vs linear rate at 20°C
 Full step, Unipolar, L/R drive

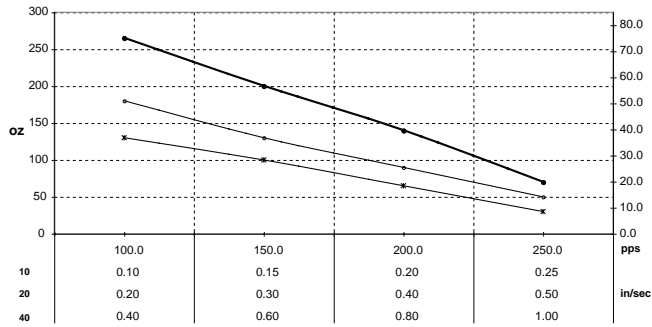

● 42DBL10CXU-K/L Pull-In Force
 ○ 42DBL20CXU-K/L Pull-In Force
 * 42DBL40CXU-K/L Pull-In Force

42DBLXXCXB-K/L
 Typical pull-in linear force vs linear rate at 20°C
 Full step, Bipolar, L/R drive

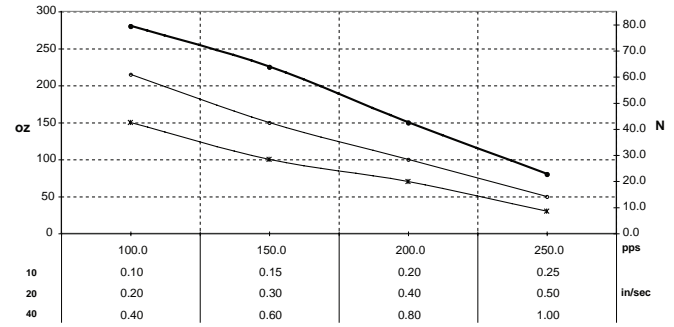

● 42DBL10CXU-K/L Pull-In Force
 ○ 42DBL20CXU-K/L Pull-In Force
 * 42DBL40CXU-K/L Pull-In Force

57DBMXXBXU-K/L
 Typical pull-in linear force vs linear rate at 20°C
 Full step, Unipolar, L/R drive

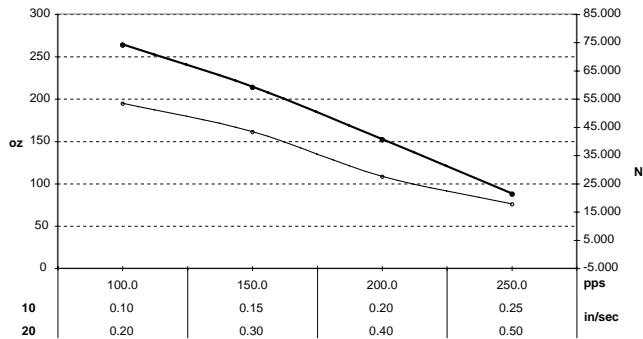

● 57DBM10BXU-K/L Pull-In Force
 ○ 57DBM20BXU-K/L Pull-In Force

57DBMXXBxB-K/L
 Typical pull-in linear force vs linear rate at 20°C
 Full step, Bipolar, L/R drive

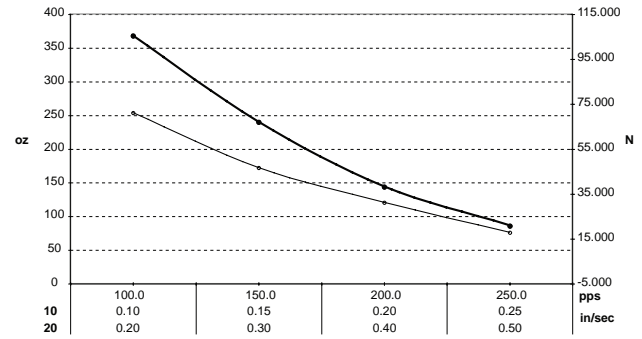

● 57DBM10BxB-K/L Pull-In Force
 ○ 57DBM20BxB-K/L Pull-In Force