



Grayhill, Inc.

62S11-H9-040C

Numero di parte:

62S11-H9-040C

Costruttore / Marca:

Grayhill, Inc.

Descrizione del prodotto

ROTARY ENCODER OPTICAL 32PPR

Schede tecniche:

 62S11-H9-040C.pdf

Stato di RoHS

 Senza piombo / RoHS

Condizione di scorta

1975 pcs stock

Nave da

Hong Kong

Modo di spedizione

DHL/Fedex/TNT/UPS/EMS

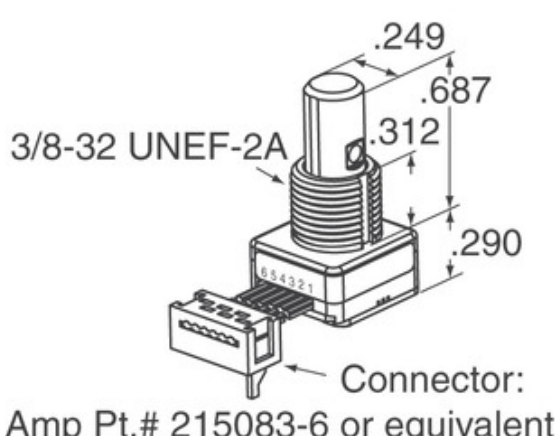

L'immagine può essere rappresentativa. Vedi le specifiche per i dettagli del prodotto.

RICHIESTA DI OFFERTA



Specifiche di 62S11-H9-040C

NUMERO DI PARTE	62S11-H9-040C
FABBRICANTE	Grayhill, Inc.
DESCRIZIONE	ROTARY ENCODER OPTICAL 32PPR
STATO LEAD SENZA PIOMBO / ROHS	Senza piombo / RoHS
QUANTITÀ DISPONIBILE	1975 pcs
SCHEDA DATI	 62S11-H9-040C.pdf
TENSIONE DI ALIMENTAZIONE -	5V
STILE DI TERMINAZIONE	Cable with Connector
SERIE	62S
DURATA DI ROTAZIONE (CICLI AL MINUTO)	1M
IMPULSI PER GIRO	32
TIPO DI USCITA	Quadrature (Incremental)
ALTRI NOMI	62S11H9040C
ORIENTAMENTO	Vertical
TIPO MONTAGGIO	Panel Mount
MOISTURE SENSITIVITY LEVEL (MSL)	1 (Unlimited)
STATO SENZA PIOMBO / STATO ROHS	Lead free / RoHS Compliant
TIPO DI CODIFICATORE	Optical
ARRESTO	Yes
INTERRUTTORE INTEGRATO	Yes
TIPO DI ATTUATORE	1/4" Dia Flatted End

Tag correlati

Grayhill, Inc. 62S11-H9-040C	Distributore 62S11-H9-040C	Fornitore 62S11-H9-040C
Prezzo 62S11-H9-040C	Immagini 62S11-H9-040C	Immagine 62S11-H9-040C
Scheda tecnica 62S11-H9-040C PDF	62S11-H9-040C Scarica la scheda tecnica	Datasheet 62S11-H9-040C
Azione 62S11-H9-040C	Acquista 62S11-H9-040C	Acquista Grayhill, Inc. 62S11-H9-040C
Grayhill, Inc. 62S11-H9-040C	Fornitore Grayhill, Inc.	Distributore Grayhill, Inc.
Grayhill, Inc. 62S11-H9-040C	Grayhill Inc. 62S11-H9-040C	

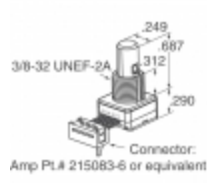
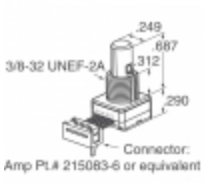
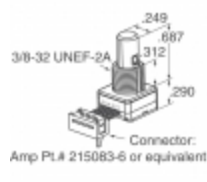
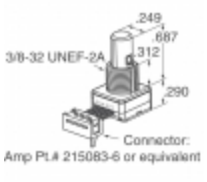
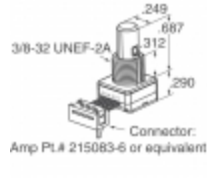
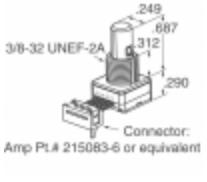
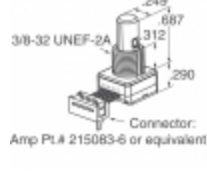
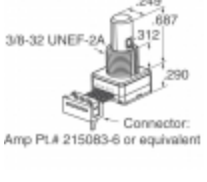
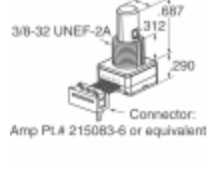
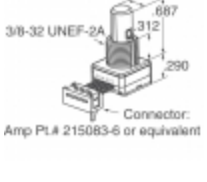
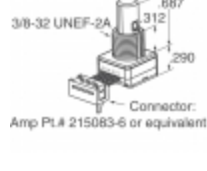
prodotti correlati

 <p>62S11-H9-050S Produttori: Grayhill, Inc. Descrizione: ROTARY ENCODER OPTICAL 32PPR disponibile: 1839 pcs</p> <p>RFQ</p>	 <p>62S11-H9-060SH Produttori: Grayhill, Inc. Descrizione: ROTARY ENCODER OPTICAL 32PPR disponibile: 1966 pcs</p> <p>RFQ</p>
 <p>62S11-H9-025S Produttori: Grayhill, Inc. Descrizione: ROTARY ENCODER OPTICAL 32PPR disponibile: 2155 pcs</p> <p>RFQ</p>	 <p>62S11-H9-040S Produttori: Grayhill, Inc. Descrizione: ROTARY ENCODER OPTICAL 32PPR disponibile: 2086 pcs</p> <p>RFQ</p>
 <p>62S11-H9-P Produttori: Grayhill, Inc. Descrizione: ROTARY ENCODER OPTICAL 32PPR disponibile: 2159 pcs</p> <p>RFQ</p>	 <p>62S11-H9-020C Produttori: Grayhill, Inc. Descrizione: ROTARY ENCODER OPTICAL 32PPR disponibile: 2176 pcs</p> <p>RFQ</p>
 <p>62S11-H9-060C Produttori: Grayhill, Inc. Descrizione: ROTARY ENCODER OPTICAL 32PPR disponibile: 2172 pcs</p> <p>RFQ</p>	 <p>62S11-H9-020S Produttori: Grayhill, Inc. Descrizione: ROTARY ENCODER OPTICAL 32PPR disponibile: 2170 pcs</p> <p>RFQ</p>
 <p>62S11-H9-PH Produttori: Grayhill, Inc. Descrizione: ROTARY ENCODER OPTICAL 32PPR disponibile: 2090 pcs</p> <p>RFQ</p>	 <p>62S11-H0-PH Produttori: Grayhill, Inc. Descrizione: ROTARY ENCODER OPTICAL 32PPR disponibile: 2006 pcs</p> <p>RFQ</p>
 <p>62S11-H0-200S Produttori: Grayhill, Inc. Descrizione: ROTARY ENCODER OPTICAL 32PPR disponibile: 1933 pcs</p> <p>RFQ</p>	 <p>62S11-H0-P Produttori: Grayhill, Inc. Descrizione: ROTARY ENCODER OPT 32PPR 10" CBL disponibile: 2508 pcs</p> <p>RFQ</p>

Copyright © 2020 Distributore affidabile dei componenti elettronici

E-mail: Info@infinity-electronic.com

Indirizzo: 17F, edificio commerciale Gaylord, 114-118 Lockhart Road, Wan Chai, Hong Kong

