



Grayhill, Inc.

62S11-H0-060SH

Numero di parte:

62S11-H0-060SH

Costruttore / Marca:

Grayhill, Inc.

Descrizione del prodotto

ROTARY ENCODER OPTICAL 32PPR

Schede tecniche:

 62S11-H0-060SH.pdf

Stato di RoHS

 Senza piombo / RoHS

Condizione di scorta

2339 pcs stock

Nave da

Hong Kong

Modo di spedizione

DHL/Fedex/TNT/UPS/EMS

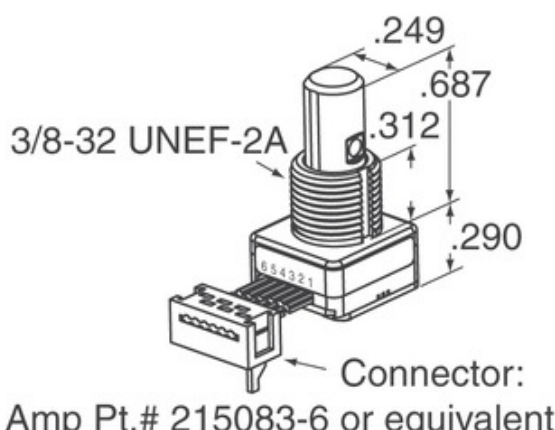

L'immagine può essere rappresentativa. Vedi le specifiche per i dettagli del prodotto.





Specifiche di 62S11-H0-060SH

NUMERO DI PARTE	62S11-H0-060SH
FABBRICANTE	Grayhill, Inc.
DESCRIZIONE	ROTARY ENCODER OPTICAL 32PPR
STATO LEAD SENZA PIOMBO / ROHS	Senza piombo / RoHS
QUANTITÀ DISPONIBILE	2339 pcs
SCHEDA DATI	 62S11-H0-060SH.pdf
TENSIONE DI ALIMENTAZIONE -	5V
STILE DI TERMINAZIONE	Cable with Connector
SERIE	62S
DURATA DI ROTAZIONE (CICLI AL MINUTO)	1M
IMPULSI PER GIRO	32
TIPO DI USCITA	Quadrature (Incremental)
ALTRI NOMI	62S11H0060SH
ORIENTAMENTO	Vertical
TIPO MONTAGGIO	Panel Mount
MOISTURE SENSITIVITY LEVEL (MSL)	1 (Unlimited)
STATO SENZA PIOMBO / STATO ROHS	Lead free / RoHS Compliant
TIPO DI CODIFICATORE	Optical
ARRESTO	Yes
INTERRUTTORE INTEGRATO	No
TIPO DI ATTUATORE	1/4" Dia Flatted End

Tag correlati

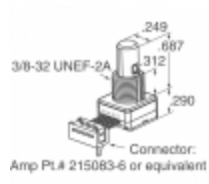
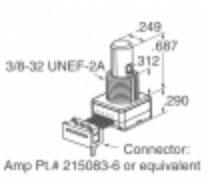
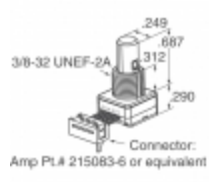
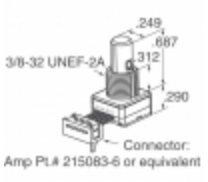
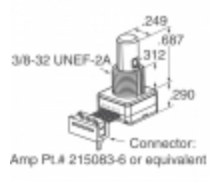
Grayhill, Inc. 62S11-H0-060SH	Distributore 62S11-H0-060SH	Fornitore 62S11-H0-060SH
Prezzo 62S11-H0-060SH	Immagini 62S11-H0-060SH	Immagine 62S11-H0-060SH
Scheda tecnica 62S11-H0-060SH PDF	62S11-H0-060SH Scarica la scheda tecnica	Datasheet 62S11-H0-060SH
Azione 62S11-H0-060SH	Acquista 62S11-H0-060SH	Acquista Grayhill, Inc. 62S11-H0-060SH
Grayhill, Inc. 62S11-H0-060SH	Fornitore Grayhill, Inc.	Distributore Grayhill, Inc.
Grayhill, Inc. 62S11-H0-060SH	Grayhill Inc. 62S11-H0-060SH	

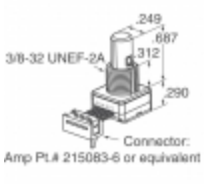
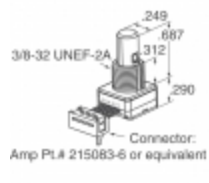
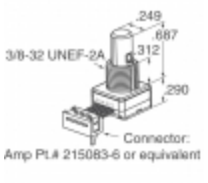
prodotti correlati

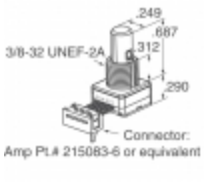
 <p>62S11-H0-060C Produttori: Grayhill, Inc. Descrizione: ROTARY ENCODER OPTICAL 32PPR disponibile: 2181 pcs</p> <p>RFQ</p>	 <p>62S11-H0-200S Produttori: Grayhill, Inc. Descrizione: ROTARY ENCODER OPTICAL 32PPR disponibile: 1933 pcs</p> <p>RFQ</p>
 <p>62S11-H9-025S Produttori: Grayhill, Inc. Descrizione: ROTARY ENCODER OPTICAL 32PPR disponibile: 2155 pcs</p> <p>RFQ</p>	 <p>62S11-H9-020C Produttori: Grayhill, Inc. Descrizione: ROTARY ENCODER OPTICAL 32PPR disponibile: 2176 pcs</p> <p>RFQ</p>
 <p>62S11-H0-PH Produttori: Grayhill, Inc. Descrizione: ROTARY ENCODER OPTICAL 32PPR disponibile: 2006 pcs</p> <p>RFQ</p>	 <p>62S11-H0-040C Produttori: Grayhill, Inc. Descrizione: ROTARY ENCODER OPT 32PPR 2" CBL disponibile: 2505 pcs</p> <p>RFQ</p>
 <p>62S11-H0-030C Produttori: Grayhill, Inc. Descrizione: ROTARY ENCODER OPT 32PPR 2" CBL disponibile: 2314 pcs</p> <p>RFQ</p>	 <p>62S11-H9-020S Produttori: Grayhill, Inc. Descrizione: ROTARY ENCODER OPTICAL 32PPR disponibile: 2170 pcs</p> <p>RFQ</p>
 <p>62S11-H0-020S Produttori: Grayhill, Inc. Descrizione: ROTARY ENCODER OPTICAL 32PPR disponibile: 1990 pcs</p> <p>RFQ</p>	 <p>62S11-H9-040C Produttori: Grayhill, Inc. Descrizione: ROTARY ENCODER OPTICAL 32PPR disponibile: 1975 pcs</p> <p>RFQ</p>
 <p>62S11-H0-P Produttori: Grayhill, Inc. Descrizione: ROTARY ENCODER OPT 32PPR 10" CBL disponibile: 2508 pcs</p> <p>RFQ</p>	 <p>62S11-H0-020C Produttori: Grayhill, Inc. Descrizione: ROTARY ENCODER OPTICAL 32PPR disponibile: 2219 pcs</p> <p>RFQ</p>

Copyright © 2020 Distributore affidabile dei componenti elettronici

E-mail: Info@infinity-electronic.com

Indirizzo: 17F, edificio commerciale Gaylord, 114-118 Lockhart Road, Wan Chai, Hong Kong

