



Grayhill, Inc.

62S11-H0-200S

Numero di parte:

62S11-H0-200S

Costruttore / Marca:

Grayhill, Inc.

Descrizione del prodotto

ROTARY ENCODER OPTICAL 32PPR

Schede tecniche:

 62S11-H0-200S.pdf

Stato di RoHS

 Senza piombo / RoHS

Condizione di scorta

1933 pcs stock

Nave da

Hong Kong

Modo di spedizione

DHL/Fedex/TNT/UPS/EMS

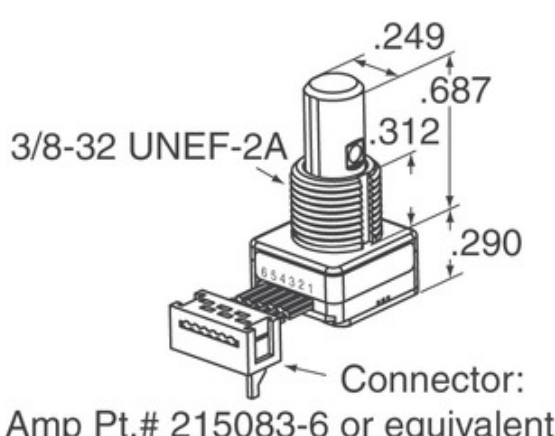

L'immagine può essere rappresentativa. Vedi le specifiche per i dettagli del prodotto.

RICHIESTA DI OFFERTA







Specifiche di 62S11-H0-200S

NUMERO DI PARTE	62S11-H0-200S
FABBRICANTE	Grayhill, Inc.
DESCRIZIONE	ROTARY ENCODER OPTICAL 32PPR
STATO LEAD SENZA PIOMBO / ROHS	Senza piombo / RoHS
QUANTITÀ DISPONIBILE	1933 pcs
SCHEDA DATI	 62S11-H0-200S.pdf
TENSIONE DI ALIMENTAZIONE -	5V
STILE DI TERMINAZIONE	Cable Leads
SERIE	62S
DURATA DI ROTAZIONE (CICLI AL MINUTO)	1M
IMPULSI PER GIRO	32
TIPO DI USCITA	Quadrature (Incremental)
ALTRI NOMI	62S11H0200S
ORIENTAMENTO	Vertical
TIPO MONTAGGIO	Panel Mount
MOISTURE SENSITIVITY LEVEL (MSL)	1 (Unlimited)
STATO SENZA PIOMBO / STATO ROHS	Lead free / RoHS Compliant
TIPO DI CODIFICATORE	Optical
ARRESTO	Yes
INTERRUTTORE INTEGRATO	No
TIPO DI ATTUATORE	1/4" Dia Flatted End

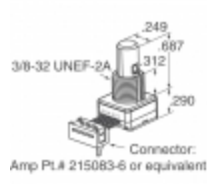
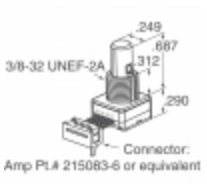
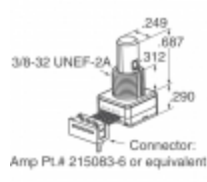
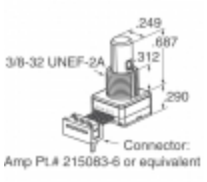
Tag correlati

Grayhill, Inc. 62S11-H0-200S	Distributore 62S11-H0-200S	Fornitore 62S11-H0-200S
Prezzo 62S11-H0-200S	Immagini 62S11-H0-200S	Immagine 62S11-H0-200S
Scheda tecnica 62S11-H0-200S PDF	62S11-H0-200S Scarica la scheda tecnica	Datasheet 62S11-H0-200S
Azione 62S11-H0-200S	Acquista 62S11-H0-200S	Acquista Grayhill, Inc. 62S11-H0-200S
Grayhill, Inc. 62S11-H0-200S	Fornitore Grayhill, Inc.	Distributore Grayhill, Inc.
Grayhill, Inc. 62S11-H0-200S	Grayhill Inc. 62S11-H0-200S	

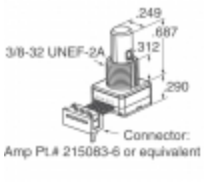
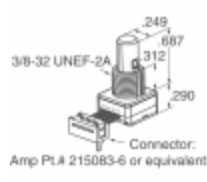
prodotti correlati

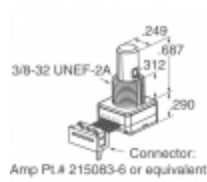
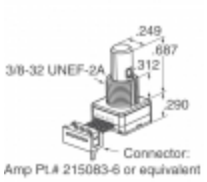
 <p>62S11-H0-060C Produttori: Grayhill, Inc. Descrizione: ROTARY ENCODER OPTICAL 32PPR disponibile: 2181 pcs</p> <p>RFQ</p>	 <p>62S11-H9-040C Produttori: Grayhill, Inc. Descrizione: ROTARY ENCODER OPTICAL 32PPR disponibile: 1975 pcs</p> <p>RFQ</p>
 <p>62S11-H9-020S Produttori: Grayhill, Inc. Descrizione: ROTARY ENCODER OPTICAL 32PPR disponibile: 2170 pcs</p> <p>RFQ</p>	 <p>62S11-H9-025S Produttori: Grayhill, Inc. Descrizione: ROTARY ENCODER OPTICAL 32PPR disponibile: 2155 pcs</p> <p>RFQ</p>
 <p>62S11-H0-030C Produttori: Grayhill, Inc. Descrizione: ROTARY ENCODER OPT 32PPR 2" CBL disponibile: 2314 pcs</p> <p>RFQ</p>	 <p>62S11-H0-PH Produttori: Grayhill, Inc. Descrizione: ROTARY ENCODER OPTICAL 32PPR disponibile: 2006 pcs</p> <p>RFQ</p>
 <p>62S11-H0-P Produttori: Grayhill, Inc. Descrizione: ROTARY ENCODER OPT 32PPR 10" CBL disponibile: 2508 pcs</p> <p>RFQ</p>	 <p>62S11-H9-020C Produttori: Grayhill, Inc. Descrizione: ROTARY ENCODER OPTICAL 32PPR disponibile: 2176 pcs</p> <p>RFQ</p>
 <p>62S11-H0-020S Produttori: Grayhill, Inc. Descrizione: ROTARY ENCODER OPTICAL 32PPR disponibile: 1990 pcs</p> <p>RFQ</p>	 <p>62S11-H0-040C Produttori: Grayhill, Inc. Descrizione: ROTARY ENCODER OPT 32PPR 2" CBL disponibile: 2505 pcs</p> <p>RFQ</p>
 <p>62S11-H0-020C Produttori: Grayhill, Inc. Descrizione: ROTARY ENCODER OPTICAL 32PPR disponibile: 2219 pcs</p> <p>RFQ</p>	 <p>62S11-H0-060SH Produttori: Grayhill, Inc. Descrizione: ROTARY ENCODER OPTICAL 32PPR disponibile: 2339 pcs</p> <p>RFQ</p>

Copyright © 2020 Distributore affidabile dei componenti elettronici

E-mail: Info@infinity-electronic.com

Indirizzo: 17F, edificio commerciale Gaylord, 114-118 Lockhart Road, Wan Chai, Hong Kong

