



Grayhill, Inc.

62S11-L0-020CH

Numero di parte:

62S11-L0-020CH

Costruttore / Marca:

Grayhill, Inc.

Descrizione del prodotto

ROTARY ENCODER OPTICAL 32PPR

Schede tecniche:

 62S11-L0-020CH.pdf

Stato di RoHS

 Senza piombo / RoHS

Condizione di scorta

2105 pcs stock

Nave da

Hong Kong

Modo di spedizione

DHL/Fedex/TNT/UPS/EMS

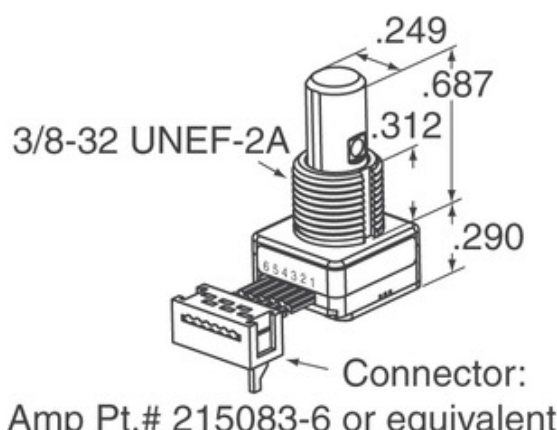

L'immagine può essere rappresentativa. Vedi le specifiche per i dettagli del prodotto.



Specifiche di 62S11-L0-020CH

NUMERO DI PARTE	62S11-L0-020CH
FABBRICANTE	Grayhill, Inc.
DESCRIZIONE	ROTARY ENCODER OPTICAL 32PPR
STATO LEAD SENZA PIOMBO / ROHS	Senza piombo / RoHS
QUANTITÀ DISPONIBILE	2105 pcs
SCHEDA DATI	 62S11-L0-020CH.pdf
TENSIONE DI ALIMENTAZIONE -	5V
STILE DI TERMINAZIONE	Cable with Connector
SERIE	62S
DURATA DI ROTAZIONE (CICLI AL MINUTO)	1M
IMPULSI PER GIRO	32
TIPO DI USCITA	Quadrature (Incremental)
ALTRI NOMI	62S11L0020CH
ORIENTAMENTO	Vertical
TIPO MONTAGGIO	Panel Mount
MOISTURE SENSITIVITY LEVEL (MSL)	1 (Unlimited)
STATO SENZA PIOMBO / STATO ROHS	Lead free / RoHS Compliant
TIPO DI CODIFICATORE	Optical
ARRESTO	Yes
INTERRUTTORE INTEGRATO	No
TIPO DI ATTUATORE	1/4" Dia Flatted End

Tag correlati

Grayhill, Inc. 62S11-L0-020CH	Distributore 62S11-L0-020CH	Fornitore 62S11-L0-020CH
Prezzo 62S11-L0-020CH	Immagini 62S11-L0-020CH	Immagine 62S11-L0-020CH
Scheda tecnica 62S11-L0-020CH PDF	62S11-L0-020CH Scarica la scheda tecnica	Datasheet 62S11-L0-020CH
Azione 62S11-L0-020CH	Acquista 62S11-L0-020CH	Acquista Grayhill, Inc. 62S11-L0-020CH
Grayhill, Inc. 62S11-L0-020CH	Fornitore Grayhill, Inc.	Distributore Grayhill, Inc.
Grayhill, Inc. 62S11-L0-020CH	Grayhill Inc. 62S11-L0-020CH	

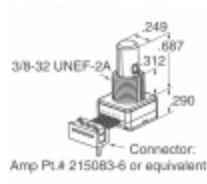
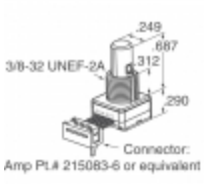
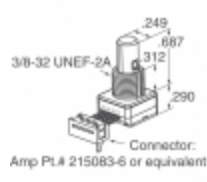
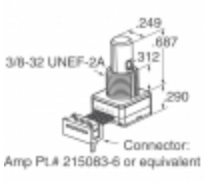
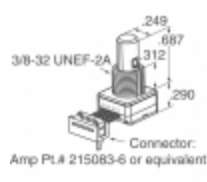
prodotti correlati

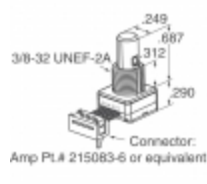
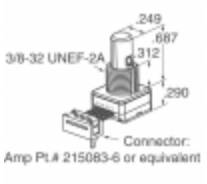
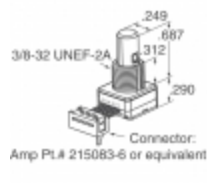
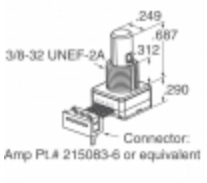
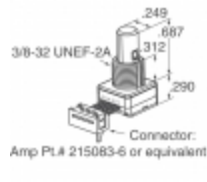
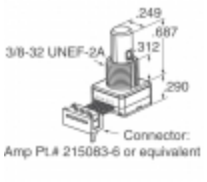
 <p>62S11-H9-P Produttori: Grayhill, Inc. Descrizione: ROTARY ENCODER OPTICAL 32PPR disponibile: 2159 pcs</p> <p>RFQ</p>	 <p>62S11-L0-060S Produttori: Grayhill, Inc. Descrizione: ROTARY ENCODER OPTICAL 32PPR disponibile: 2241 pcs</p> <p>RFQ</p>
 <p>62S11-H9-PH Produttori: Grayhill, Inc. Descrizione: ROTARY ENCODER OPTICAL 32PPR disponibile: 2090 pcs</p> <p>RFQ</p>	 <p>62S11-L0-020C Produttori: Grayhill, Inc. Descrizione: ROTARY ENCODER OPTICAL 32PPR disponibile: 1839 pcs</p> <p>RFQ</p>
 <p>62S11-L0-055C Produttori: Grayhill, Inc. Descrizione: ROTARY ENCODER OPTICAL 32PPR disponibile: 1995 pcs</p> <p>RFQ</p>	 <p>62S11-L0-040S Produttori: Grayhill, Inc. Descrizione: ROTARY ENCODER OPT 32PPR 4" CBL disponibile: 2058 pcs</p> <p>RFQ</p>
 <p>62S11-H9-060SH Produttori: Grayhill, Inc. Descrizione: ROTARY ENCODER OPTICAL 32PPR disponibile: 1966 pcs</p> <p>RFQ</p>	 <p>62S11-L0-040C Produttori: Grayhill, Inc. Descrizione: ROTARY ENCODER OPTICAL 32PPR disponibile: 2079 pcs</p> <p>RFQ</p>
 <p>62S11-H9-050S Produttori: Grayhill, Inc. Descrizione: ROTARY ENCODER OPTICAL 32PPR disponibile: 1839 pcs</p> <p>RFQ</p>	 <p>62S11-H9-060C Produttori: Grayhill, Inc. Descrizione: ROTARY ENCODER OPTICAL 32PPR disponibile: 2172 pcs</p> <p>RFQ</p>
 <p>62S11-L0-060SH Produttori: Grayhill, Inc. Descrizione: ROTARY ENCODER OPTICAL 32PPR disponibile: 2073 pcs</p> <p>RFQ</p>	 <p>62S11-L0-060CH Produttori: Grayhill, Inc. Descrizione: ROTARY ENCODER OPTICAL 32PPR disponibile: 1935 pcs</p> <p>RFQ</p>

Copyright © 2020 Distributore affidabile dei componenti elettronici

E-mail: Info@infinity-electronic.com

Indirizzo: 17F, edificio commerciale Gaylord, 114-118 Lockhart Road, Wan Chai, Hong Kong

