



Grayhill, Inc.

62S11-L0-P

Numero di parte:

62S11-L0-P

Costruttore / Marca:

Grayhill, Inc.

Descrizione del prodotto

ROTARY ENCODER OPTICAL 32PPR

Schede tecniche:

 62S11-L0-P.pdf

Stato di RoHS

 Senza piombo / RoHS

Condizione di scorta

2100 pcs stock

Nave da

Hong Kong

Modo di spedizione

DHL/Fedex/TNT/UPS/EMS

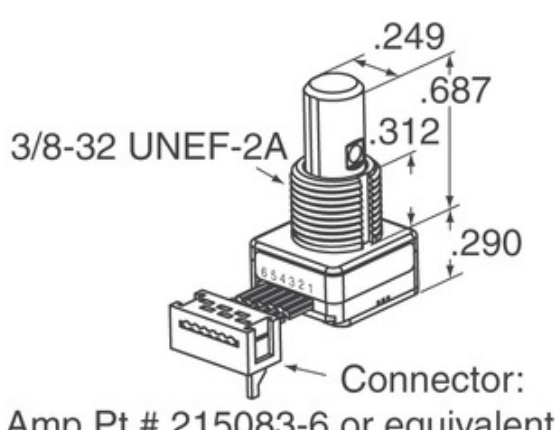
RICHIESTA DI OFFERTA

L'immagine può essere rappresentativa. Vedi le specifiche per i dettagli del prodotto.





Specifiche di 62S11-L0-P

NUMERO DI PARTE	62S11-L0-P
FABBRICANTE	Grayhill, Inc.
DESCRIZIONE	ROTARY ENCODER OPTICAL 32PPR
STATO LEAD SENZA PIOMBO / ROHS	Senza piombo / RoHS
QUANTITÀ DISPONIBILE	2100 pcs
SCHEDA DATI	 62S11-L0-P.pdf
TENSIONE DI ALIMENTAZIONE -	5V
STILE DI TERMINAZIONE	PC Pin
SERIE	62S
DURATA DI ROTAZIONE (CICLI AL MINUTO)	1M
IMPULSI PER GIRO	32
TIPO DI USCITA	Quadrature (Incremental)
ALTRI NOMI	62S11L0P
ORIENTAMENTO	Vertical
TIPO MONTAGGIO	PCB, Through Hole
MOISTURE SENSITIVITY LEVEL (MSL)	1 (Unlimited)
STATO SENZA PIOMBO / STATO ROHS	Lead free / RoHS Compliant
TIPO DI CODIFICATORE	Optical
ARRESTO	Yes
INTERRUTTORE INTEGRATO	No
TIPO DI ATTUATORE	1/4" Dia Flatted End

Tag correlati

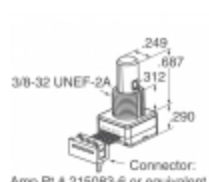
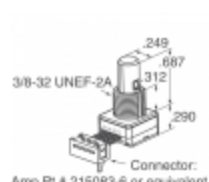
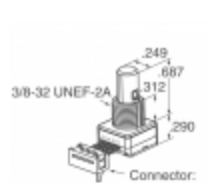
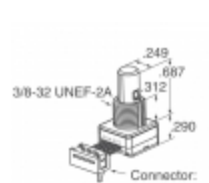
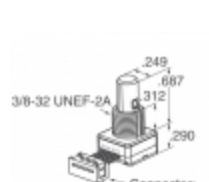
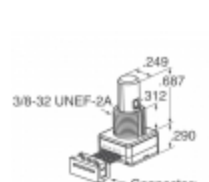
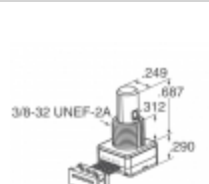
Grayhill, Inc. 62S11-L0-P	Distributore 62S11-L0-P	Fornitore 62S11-L0-P
Prezzo 62S11-L0-P	Immagini 62S11-L0-P	Immagine 62S11-L0-P
Scheda tecnica 62S11-L0-P PDF	62S11-L0-P Scarica la scheda tecnica	Datasheet 62S11-L0-P
Azione 62S11-L0-P	Acquista 62S11-L0-P	Acquista Grayhill, Inc. 62S11-L0-P
Grayhill, Inc. 62S11-L0-P	Fornitore Grayhill, Inc.	Distributore Grayhill, Inc.
Grayhill, Inc. 62S11-L0-P	Grayhill Inc. 62S11-L0-P	

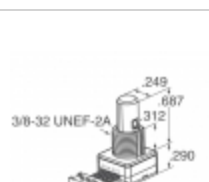
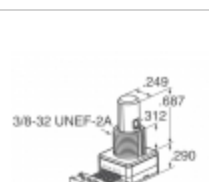
prodotti correlati

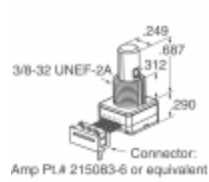
 <p>62S11-L4-025SH Produttori: Grayhill, Inc. Descrizione: ROTARY ENCODER OPTICAL 32PPR disponibile: 2264 pcs</p> <p>RFQ</p>	 <p>62S11-L0-060CH Produttori: Grayhill, Inc. Descrizione: ROTARY ENCODER OPTICAL 32PPR disponibile: 1935 pcs</p> <p>RFQ</p>
 <p>62S11-L0-055C Produttori: Grayhill, Inc. Descrizione: ROTARY ENCODER OPTICAL 32PPR disponibile: 1995 pcs</p> <p>RFQ</p>	 <p>62S11-L4-020S Produttori: Grayhill, Inc. Descrizione: ROTARY ENCODER OPT 32PPR 2" CBL disponibile: 1879 pcs</p> <p>RFQ</p>
 <p>62S11-L0-PH Produttori: Grayhill, Inc. Descrizione: ROTARY ENCODER OPTICAL 32PPR disponibile: 2460 pcs</p> <p>RFQ</p>	 <p>62S11-L0-040C Produttori: Grayhill, Inc. Descrizione: ROTARY ENCODER OPTICAL 32PPR disponibile: 2079 pcs</p> <p>RFQ</p>
 <p>62S11-L4-030S Produttori: Grayhill, Inc. Descrizione: ROTARY ENCODER OPTICAL 32PPR disponibile: 1829 pcs</p> <p>RFQ</p>	 <p>62S11-L0-PHV Produttori: Grayhill, Inc. Descrizione: ROTARY ENCODER OPTICAL 32PPR disponibile: 1991 pcs</p> <p>RFQ</p>
 <p>62S11-L4-020C Produttori: Grayhill, Inc. Descrizione: ROTARY ENCODER OPTICAL 32PPR disponibile: 2162 pcs</p> <p>RFQ</p>	 <p>62S11-L0-060S Produttori: Grayhill, Inc. Descrizione: ROTARY ENCODER OPTICAL 32PPR disponibile: 2241 pcs</p> <p>RFQ</p>
 <p>62S11-L0-040S Produttori: Grayhill, Inc. Descrizione: ROTARY ENCODER OPT 32PPR 4" CBL disponibile: 2058 pcs</p> <p>RFQ</p>	 <p>62S11-L0-060SH Produttori: Grayhill, Inc. Descrizione: ROTARY ENCODER OPTICAL 32PPR disponibile: 2073 pcs</p> <p>RFQ</p>

Copyright © 2020 Distributore affidabile dei componenti elettronici

E-mail: Info@infinity-electronic.com

Indirizzo: 17F, edificio commerciale Gaylord, 114-118 Lockhart Road, Wan Chai, Hong Kong

