



Grayhill, Inc.

62S11-M9-025S

Numero di parte:

62S11-M9-025S

Costruttore / Marca:

Grayhill, Inc.

Descrizione del prodotto

ROTARY ENCODER OPTICAL 32PPR

Schede tecniche:

 62S11-M9-025S.pdf

Stato di RoHS

 Senza piombo / RoHS

Condizione di scorta

2070 pcs stock

Nave da

Hong Kong

Modo di spedizione

DHL/Fedex/TNT/UPS/EMS

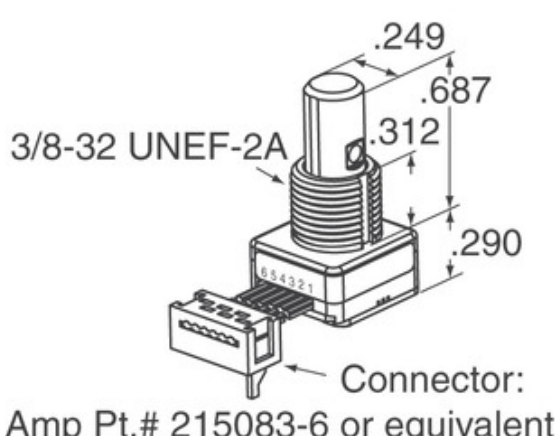

L'immagine può essere rappresentativa. Vedi le specifiche per i dettagli del prodotto.





Specifiche di 62S11-M9-025S

NUMERO DI PARTE	62S11-M9-025S
FABBRICANTE	Grayhill, Inc.
DESCRIZIONE	ROTARY ENCODER OPTICAL 32PPR
STATO LEAD SENZA PIOMBO / ROHS	Senza piombo / RoHS
QUANTITÀ DISPONIBILE	2070 pcs
SCHEDA DATI	 62S11-M9-025S.pdf
TENSIONE DI ALIMENTAZIONE -	5V
STILE DI TERMINAZIONE	Cable Leads
SERIE	62S
DURATA DI ROTAZIONE (CICLI AL MINUTO)	1M
IMPULSI PER GIRO	32
TIPO DI USCITA	Quadrature (Incremental)
ALTRI NOMI	62S11M9025S
ORIENTAMENTO	Vertical
TIPO MONTAGGIO	Panel Mount
MOISTURE SENSITIVITY LEVEL (MSL)	1 (Unlimited)
STATO SENZA PIOMBO / STATO ROHS	Lead free / RoHS Compliant
TIPO DI CODIFICATORE	Optical
ARRESTO	Yes
INTERRUTTORE INTEGRATO	Yes
TIPO DI ATTUATORE	1/4" Dia Flatted End

Tag correlati

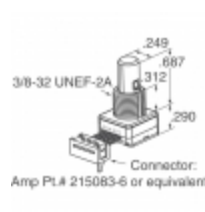
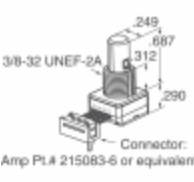
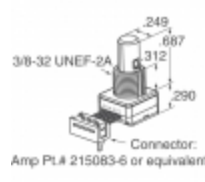
Grayhill, Inc. 62S11-M9-025S	Distributore 62S11-M9-025S	Fornitore 62S11-M9-025S
Prezzo 62S11-M9-025S	Immagini 62S11-M9-025S	Immagine 62S11-M9-025S
Scheda tecnica 62S11-M9-025S PDF	62S11-M9-025S Scarica la scheda tecnica	Datasheet 62S11-M9-025S
Azione 62S11-M9-025S	Acquista 62S11-M9-025S	Acquista Grayhill, Inc. 62S11-M9-025S
Grayhill, Inc. 62S11-M9-025S	Fornitore Grayhill, Inc.	Distributore Grayhill, Inc.
Grayhill, Inc. 62S11-M9-025S	Grayhill Inc. 62S11-M9-025S	

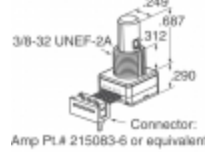
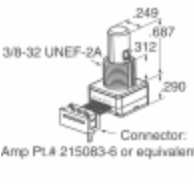
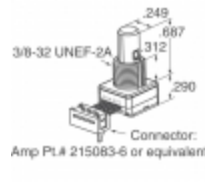
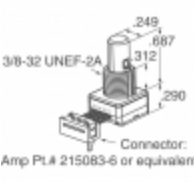
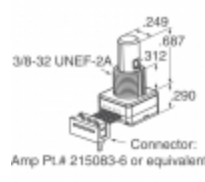
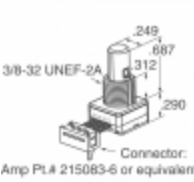
prodotti correlati

 <p>62S11-M5-P Produttori: Grayhill, Inc. Descrizione: ROTARY ENCODER OPTICAL 32PPR disponibile: 2458 pcs</p> <p>RFQ</p>	 <p>62S11-M9-095CH Produttori: Grayhill, Inc. Descrizione: ROTARY ENCODER OPTICAL 32PPR disponibile: 1978 pcs</p> <p>RFQ</p>
 <p>62S11-M9-020C Produttori: Grayhill, Inc. Descrizione: ROTARY ENCODER OPTICAL 32PPR disponibile: 2241 pcs</p> <p>RFQ</p>	 <p>62S11-M9-020S Produttori: Grayhill, Inc. Descrizione: ROTARY ENCODER OPTICAL 32PPR disponibile: 2269 pcs</p> <p>RFQ</p>
 <p>62S11-M9-020CH Produttori: Grayhill, Inc. Descrizione: ROTARY ENCODER OPTICAL 32PPR disponibile: 2097 pcs</p> <p>RFQ</p>	 <p>62S11-M9-040C Produttori: Grayhill, Inc. Descrizione: ROTARY ENCODER OPTICAL 32PPR disponibile: 1933 pcs</p> <p>RFQ</p>
 <p>62S11-M9-060C Produttori: Grayhill, Inc. Descrizione: ROTARY ENCODER OPTICAL 32PPR disponibile: 2060 pcs</p> <p>RFQ</p>	 <p>62S11-M9-040SH Produttori: Grayhill, Inc. Descrizione: ROTARY ENCODER OPT 32PPR 4" CBL disponibile: 1879 pcs</p> <p>RFQ</p>
 <p>62S11-M9-050C Produttori: Grayhill, Inc. Descrizione: ROTARY ENCODER OPTICAL 32PPR disponibile: 2082 pcs</p> <p>RFQ</p>	 <p>62S11-M9-030S Produttori: Grayhill, Inc. Descrizione: ROTARY ENCODER OPTICAL 32PPR disponibile: 1918 pcs</p> <p>RFQ</p>
 <p>62S11-M5-135S Produttori: Grayhill, Inc. Descrizione: ROTARY ENCODER OPTICAL 32PPR disponibile: 2167 pcs</p> <p>RFQ</p>	 <p>62S11-M5-PH Produttori: Grayhill, Inc. Descrizione: ROTARY ENCODER OPTICAL 32PPR disponibile: 2451 pcs</p> <p>RFQ</p>

Copyright © 2020 Distributore affidabile dei componenti elettronici

E-mail: Info@infinity-electronic.com

Indirizzo: 17F, edificio commerciale Gaylord, 114-118 Lockhart Road, Wan Chai, Hong Kong

